

Programmers Guide

C3 Controllers

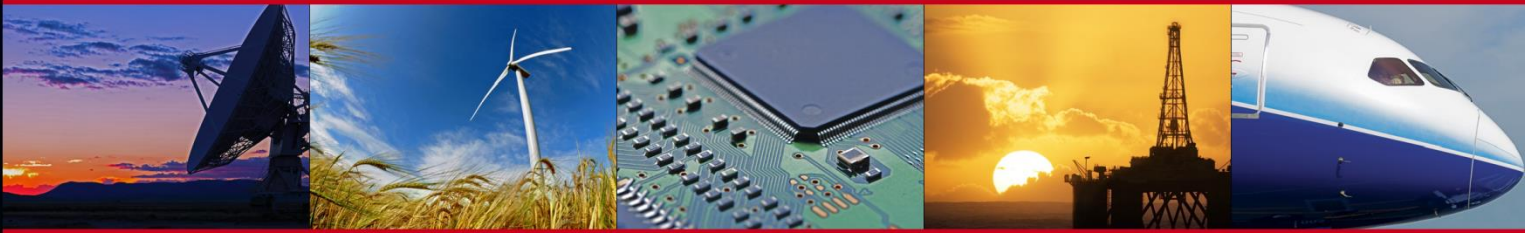

Communications - Telemetry - Automated Testing - Broadcast



Global Signal Switching and Distribution Specialists

Contents

1. INTRODUCTION.....	9
2. 4.3" FRONT PANEL	11
2.1. Power-up Splash Screen	12
2.2. Menu Tree.....	13
2.3. Home Screen.....	14
2.4. Keypad	14
2.5. Last Action.....	14
2.6. Application Title	15
2.7. Writing to Memory.....	15
2.8. Connect.....	16
2.9. Disconnect	16
2.10. Verify	16
2.11. Save and Recall Crosspoint Configurations.....	18
2.11.1. Configuration Labels.....	18
2.12. View Connections	19
2.12.1. Mod.....	19
2.12.2. Custom Labels	19
2.12.3. Signal Detect	20
2.13. Signal Exclusions	21
2.14. Menu.....	23
2.14.1. System Information.....	23
2.14.2. System Functions	28
2.14.3. Event Scheduler.....	32
2.14.4. Display Preferences.....	32
2.14.5. Remote Ctrl Settings.....	34
2.14.6. Module Settings.....	38
2.15. Channel Classes.....	41
2.15.1. Class Editor	42

2.16.	LAN Status Indicator	44
2.16.1.	Front Panel ID	44
2.16.2.	LAN Status.....	44
2.17.	Master / Remote	45
2.18.	Remote Control via RouteWarePRO	45
3.	10.1" FRONT PANEL	47
3.1.	Menu Tree	48
3.2.	Local Lock	49
3.3.	X-Point Control	50
3.3.1.	Overview	50
3.3.2.	Crosspoint Editor.....	51
3.3.3.	Crosspoint Navigator.....	52
3.3.4.	List View	53
3.3.5.	List View Editor	54
3.4.	Class Control	55
3.4.1.	Overview	55
3.4.2.	Class Editor.....	56
3.4.3.	List View	57
3.5.	Information	59
3.5.1.	About System.....	60
3.5.2.	Voltage Monitor	60
3.5.3.	Diagnostic	61
3.5.4.	Event Log	62
3.6.	System Settings	63
3.6.1.	System Functions	63
3.6.2.	Module Settings.....	66
3.6.3.	Display Preferences	67
3.6.4.	Set Date/Time.....	67
3.7.	Remote Settings	68
3.8.	Save / Recall Scheduler	69
3.8.1.	Configuration Labels	69
3.8.2.	Event Scheduler	70
3.9.	Last Action	71
4.	COMMUNICATING WITH THE SYSTEM	72

4.1. Remote Resources	73
4.1.1. Example Resource Descriptors.....	74
4.1.2. GUI and Commands Line Level of Control.....	74
5. REMOTE CONTROL COMMANDS	75
5.1. Changing Between Control Protocols	75
5.2. Syntax Conventions	76
5.3. IEEE 488.2 Compliant Command Set	77
5.3.1. System Specific Commands – Tri-Stage™.....	77
5.3.2. CONnect Command	83
5.3.3. DISconnect Command.....	83
5.3.4. MAKe? Query	83
5.3.5. BREak? Query	84
5.3.6. QUE? Query	85
5.3.7. GET? And SET Functions.....	86
5.3.8. LOCK and UNLock Commands.....	87
5.3.9. ETHernet? Query.....	87
5.3.10. *SAV and *RCL Commands	88
5.3.11. FORceclose Command:.....	89
5.3.12. RESet Command.....	89
5.3.13. *IDN? Query	89
5.3.14. *TST? Query.....	90
5.3.15. *RST Command.....	90
5.3.16. *CLS Command.....	90
5.3.17. *STB? Query	90
5.3.18. *ESR? Query.....	91
5.3.19. *ESE Command.....	91
5.3.20. *ESE? Query.....	91
5.3.21. *SRE Command	91
5.3.22. *SRE? Query.....	91
5.3.23. *PSC Command	91
5.3.24. *PSC? Query.....	91
5.3.25. *OPC Command.....	92
5.3.26. *OPC? Query	92
5.3.27. *WAI Command	92
5.3.28. POL? Query	92
5.3.29. POA Command.....	92
5.3.30. POD Command.....	93
5.3.31. LIN and LOUOut Commands	93
5.3.32. LIN? and LOUOut? Queries.....	94
5.3.33. STL Command.....	95
5.3.34. STL? Query	96
5.3.35. LOG? Query	97

5.3.36.	TIM and TIM? Functions.....	97
5.3.37.	DAT and DAT? Functions	98
5.3.38.	RFL? Query (Master / Remote Only)	98
5.3.39.	REM? Query (Master / Remote Only).....	98
5.3.40.	TOP? Query	99
5.3.41.	UDES and UDES? Functions.....	99
5.4.	Channel Classes	100
5.5.	GET? And SET Values.....	105
6.	CONTROL INFORMATION	111
6.1.	Status Byte Register.....	111
6.1.1.	Status Byte Register Layout and Description	111
6.1.2.	The Status Byte Register (SBR).....	112
6.1.3.	The Service Request Enable Register (SRER).....	113
6.1.4.	The Event Status Enabled Register (ESER)	113
6.1.5.	The Event Status Register (ESR).....	114
6.1.6.	Procedure for Recovering Errors.....	117
6.1.7.	Register Function Summary.....	118
6.1.8.	Commands to Evaluate and Control Status (488.2).....	119
6.1.9.	Overlapped Processing.....	121
6.2.	System Switching Mode	122
6.2.1.	Auto-Route Mode	122
6.2.2.	Parallel Operation.....	122
6.2.3.	Ganged Mode.....	123
6.2.4.	Poles (Virtual Modules)	124
7.	ERROR CODE LIST	125
8.	C3-001 REMOTE CONTROL ASSEMBLY.....	129
8.1.	Remote Control Interfaces.....	130
8.1.1.	10/100 Ethernet	130
8.1.2.	Serial.....	131
8.2.	Firmware Updates.....	132
8.3.	Restore to Factory Defaults	133
8.4.	C3-001 CPU LEDs.....	134
8.5.	SNMP	135
8.5.1.	SnmpB Browser	135

8.5.2.	sysSettings.MIB	139
8.5.3.	sysTRAP.MIB	139
8.5.4.	swConfig.MIB	141
9.	WEB INTERFACE	145
9.1.	System Information	146
9.2.	LAN Configuration.....	147
9.3.	SNMP Configuration.....	148
9.4.	System Settings.....	149
9.5.	Switch State	150
9.6.	Custom Labels.....	153
9.7.	Event Log	154
9.8.	Module Information	155
9.9.	Relay Cycle Log.....	156
9.10.	Diagnostic	157
9.11.	Event Scheduler.....	158
9.12.	Classing.....	159
9.13.	Firmware Maintenance.....	161
9.14.	Administrator Account.....	162
9.15.	Manufacturer Website.....	163
9.16.	Support Center.....	163
10.	MICROSD CARD	164
10.1.	microSD Card Decision Trees	165
11.	TROUBLESHOOTING	170
11.1.	Power.....	170
11.1.1.	Circuit Breakers and Fuses.....	170
11.1.2.	Power Supply	171

11.1.3.	Power Flowchart.....	172
11.2.	Communications.....	173
11.2.1.	Ethernet Communications Flowchart	174
11.2.2.	Serial Communications (RS-232, RS-422, RS-485) Flowchart	175
11.2.3.	Mechanical Connections	176
11.2.4.	Mechanical Connections Flowchart	177
11.3.	Performance.....	178
11.3.1.	Compatibility Issues.....	178
11.3.2.	Operation and Performance Flow Chart.....	179
11.4.	Technical Support.....	180
12.	CONTROL SOFTWARE	182
12.1.	RouteWarePRO.....	182
12.2.	National Instruments LabVIEW.....	183
13.	INDEX	184
14.	RECORD OF CHANGES.....	188

TECHNICAL SUPPORT

Phone +1 818-381-5111

Fax +1 818-252-4868

Email support@uswi.com

7671 North San Fernando Road
Burbank, CA 91505-1073 USA

1. Introduction

The Programmers Guide - C3 Controllers documents a variety of information that is common to many Universal Switching Corporation products. Information found in this manual includes but is not limited to the following:

- Commands and protocols used in operating Universal Switching Corporation programmable switching systems, and the Remote Control Unit Assemblies (CPU's)
- Troubleshooting techniques and Error Codes
- Front Panel control and functionality
- Firmware architecture and flowchart
- CPU varieties and functionality
- RouteWarePRO – Universal Switching Corporation's professional control and GUI Software
- National Instruments LabVIEW drivers

Please note that this document is general to Universal Switching Corporation products and should be referenced in conjunction with the system specific Operations Manual. Typically the Operations Manual will have the system model number in the title.





2. 4.3” Front Panel

This section describes the features of the front panel which includes an LCD capacitive touchscreen. The touchscreen will respond to touches by an electrical conductor such as a human finger or a capacitive stylus. The display showcases the following features:

- 4.3” Diagonal viewing area
- 480 x 272 WQVGA Resolution, full color
- Viewing Angle: 70/70 (left/right), 50/70 (up/down)
- User adjustable brightness controls
- Field upgradeable firmware via Micro SD
- RoHS Compliant

The video below shows a brief introduction to the touchscreen interface that is described throughout this manual section.

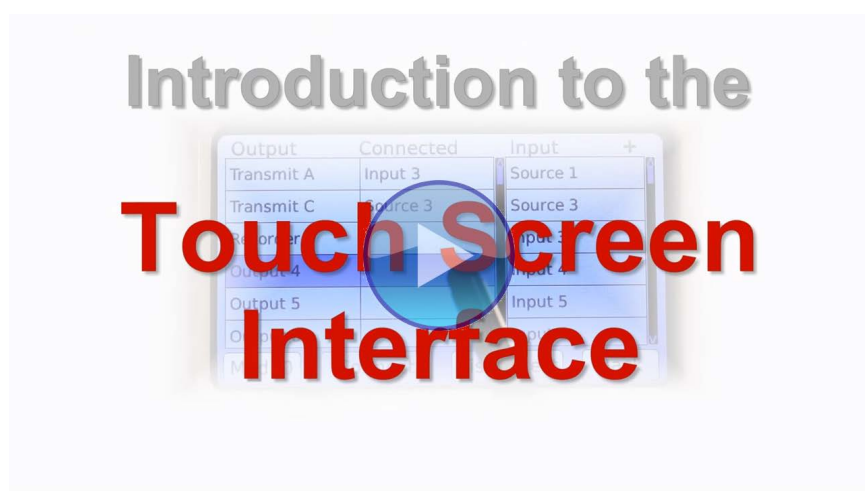

2.1. Power-up Splash Screen

The system displays a splash screen during the power-up sequence. It is displayed while the system performs its boot up sequence and establishes communications with the rest of the system.

2.2. Menu Tree

The diagram below illustrates the various menus and functions available on the front panel touchscreen display.

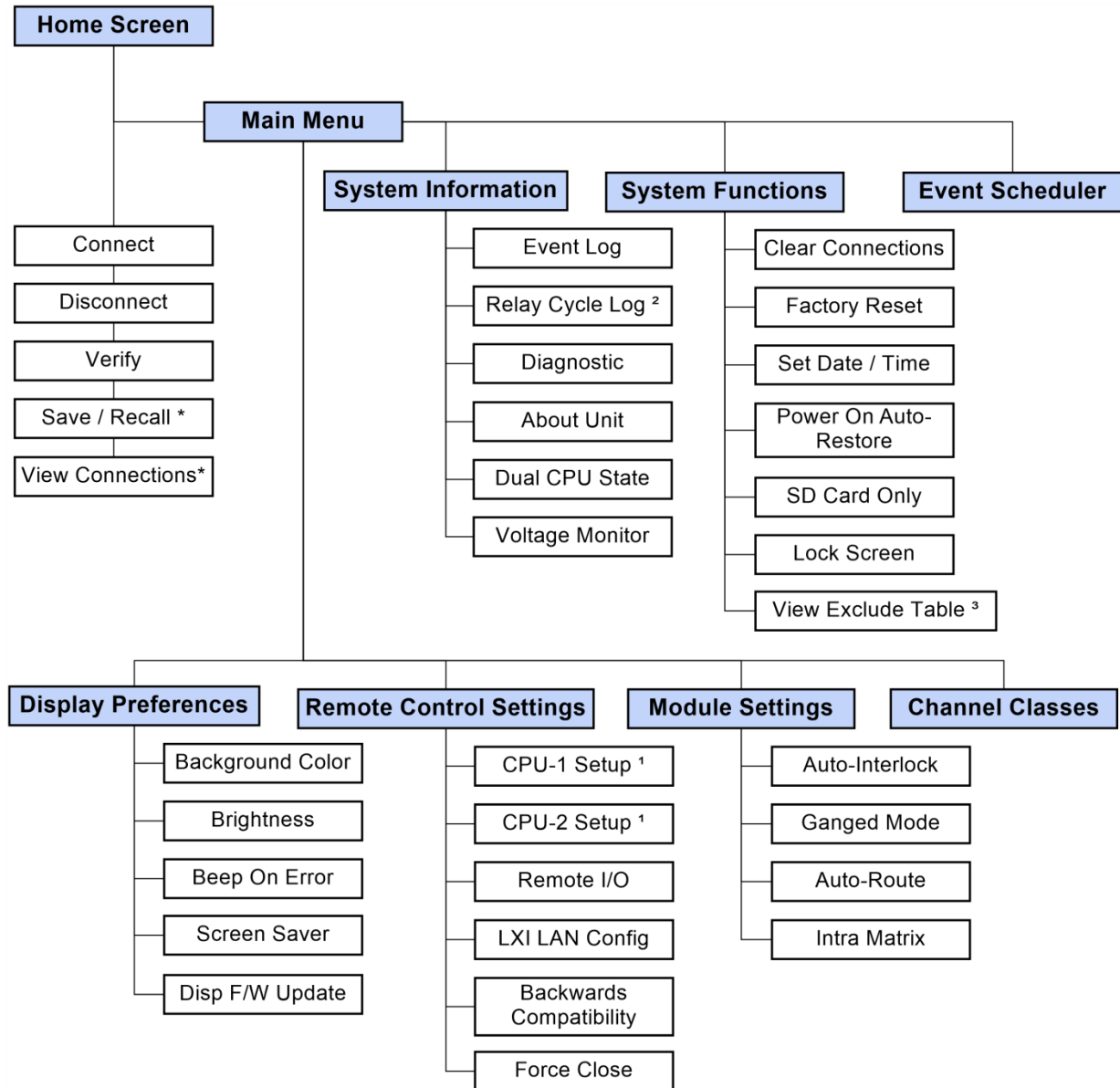

- * You may apply a custom label directly from this screen
- ¹ Setup includes IP address, DHCP mode, Serial baud rate, etc.
- ² Only available on systems with electromechanical relays.
- ³ Only available on Tri-Stage™ systems

2.3. Home Screen

This section describes the features and functions of the home screen. The home screen is the default view after the initial power on sequence is complete. It is also the main screen from which all other screens are accessed.

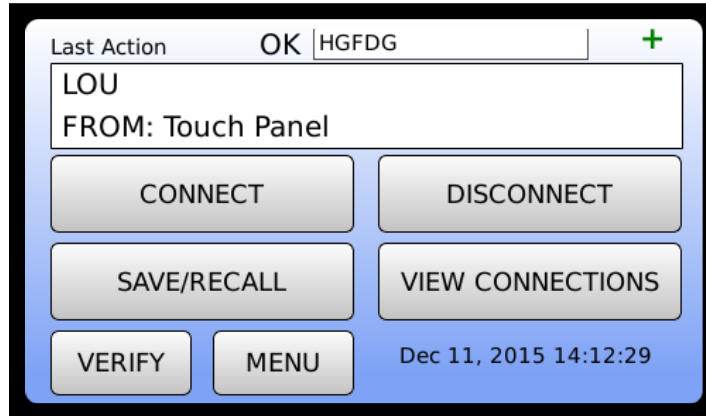

2.4. Keypad

When necessary the numerical keypad will be brought into view. In addition to the numerical keys, the following keys are defined as follows:

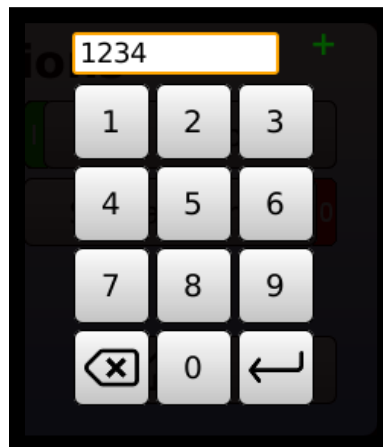

- ↵ OK
- ⌫ Backspace

2.5. Last Action

The Last Action Window of the home screen will show the results of the last action performed on the switch. Examples include

crosspoint connections, verifications, memory recall, etc. It will report actions applied via the front panel or remote interface(s).

2.6. Application Title

The Application Title can be used to identify a specific task for the system so that identification can be made by the operator. Touching the title activates a keyboard where the user may add a custom title such as "Sat Com Switch 1" etc.

2.7. Writing to Memory

When a command is sent to the system via the front panel or any remote interface that changes the status of the system in any way, the new status is written to serial flash. To indicate that a change is being made to the flash memory, a red LED type indicator is shown in the top right corner of the display as shown below.

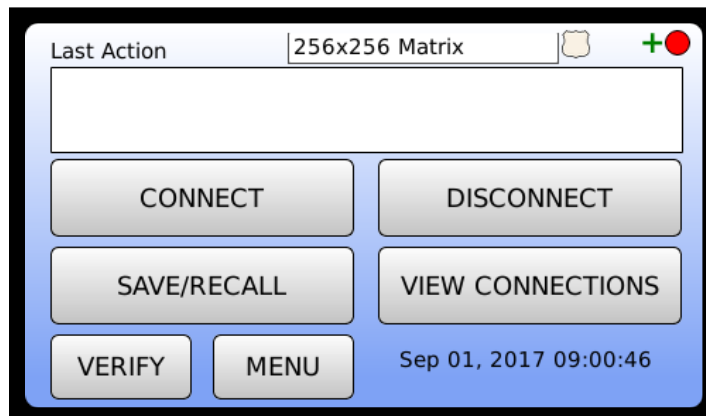

2.8. Connect

The Connect function will launch a sub-menu that allows the user to connect an input to an output. Touch the desired field for data entry to activate the keypad. Enter the numerical value of the I/O then press the "OK" button. When all required fields are complete, press the Enter button to submit the action. Pressing back will cancel the action.

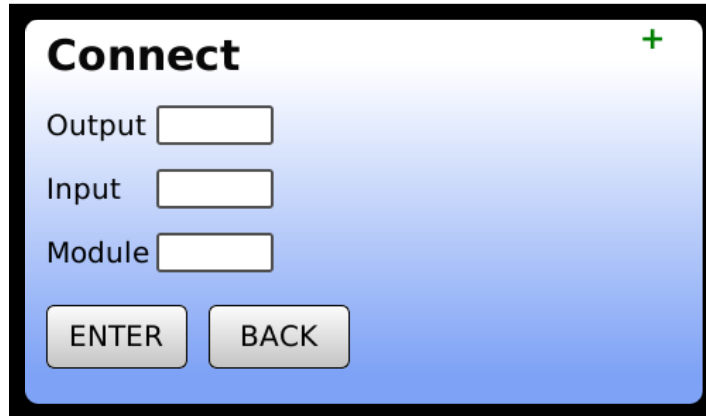

The screenshot shows a mobile application interface titled "Connect" in bold black text at the top left. A green plus sign is in the top right corner. Below the title are three input fields labeled "Output", "Input", and "Module", each with a white rectangular box. At the bottom, there are two buttons: "ENTER" and "BACK", both with a light gray background and black text.

2.9. Disconnect

The Disconnect function will launch a sub-menu that allows the user to disconnect an input from an output. Touch the desired field for data entry to activate the keypad. Enter the numerical value of the I/O then press the "OK" button. When all required fields are complete, press the Enter button to submit the action. Pressing back will cancel the action.

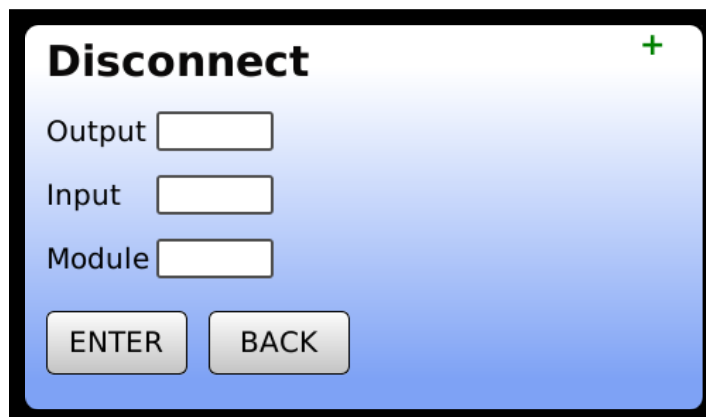

The screenshot shows a mobile application interface titled "Disconnect" in bold black text at the top left. A green plus sign is in the top right corner. Below the title are three input fields labeled "Output", "Input", and "Module", each with a white rectangular box. At the bottom, there are two buttons: "ENTER" and "BACK", both with a light gray background and black text.

2.10. Verify

The Verify function will launch a sub-menu that allows the user to verify the connection status of a specific crosspoint. Touch the desired field for data entry to activate the keypad. Enter the

numerical value of the I/O location then press the "OK" button. When all required fields are complete, press the Enter button to submit the action. Pressing back will cancel the action. The display will then show the crosspoint as being connected or disconnected.

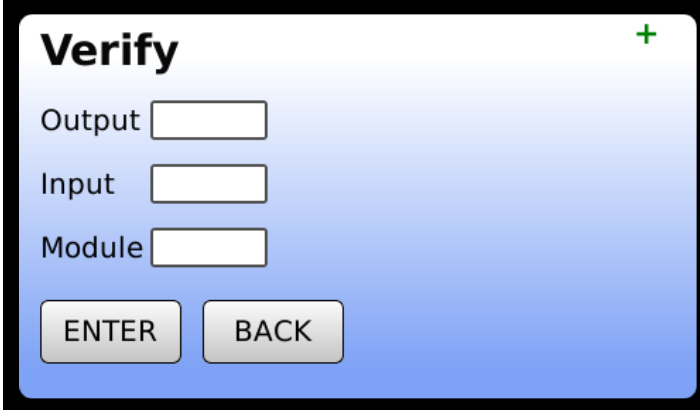

The image shows a screen titled "Verify" with a green plus sign in the top right corner. Below the title are three input fields labeled "Output", "Input", and "Module". At the bottom of the screen are two buttons labeled "ENTER" and "BACK".

2.11. Save and Recall Crosspoint Configurations

The System can save and recall different crosspoint configurations from the CPU's memory. When a configuration is saved, the entire switching array configuration is saved into the storage memory location chosen by the user. The configuration is also time stamped for identification purposes.

To save or recall a configuration, use the scroll bar on the right hand side to locate the desired numerical memory location. Touch the line item to highlight it, then select the save button to save the configuration or the recall button to recall a saved configuration. In either case, a confirmation window will appear prompting the user to confirm the action.

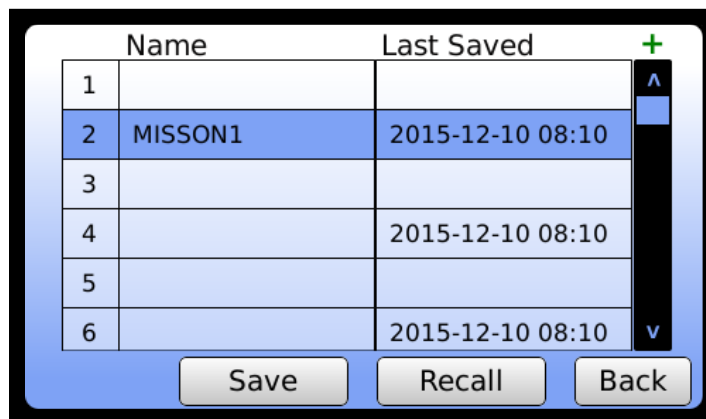

2.11.1. Configuration Labels

You may also rename a configuration to something a bit more application specific. To add a label to a saved configuration, simply press and hold the name for three seconds then edit the name with the on-screen keyboard that appears. These names may also be changed or queried remotely using the STL / STL? function described in Sections 5.3.33 and 5.3.34 (Also see Sections 9.5 and 9.6 for web GUI access).

Note that there is a ten character maximum for custom labels and restricted characters are the quotation mark, comma, and semicolon.

2.12. View Connections

The View Connections function will launch a sub-menu that allows the user to view the current crosspoint configuration. Additionally, the user may connect and disconnect crosspoints from this menu. Use the scroll bar to scroll through each list of outputs and inputs.

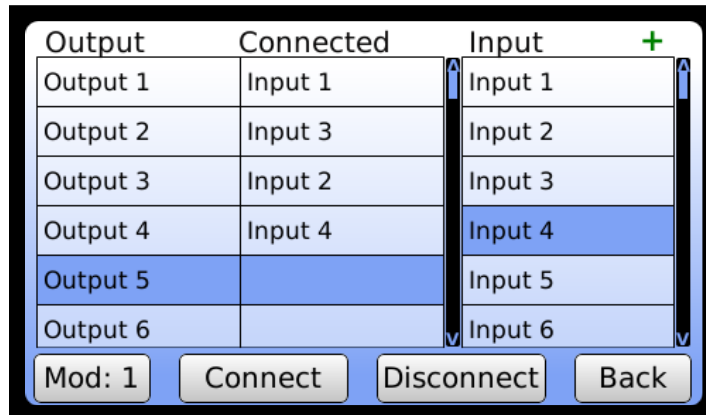

2.12.1. Mod

The Mod button should be used to select the module you want the crosspoint to be applied to. This may not be applicable in all configurations and you should refer to the System Operators Manual for your system to determine how many modules are available and their input / output configurations.

2.12.2. Custom Labels

Users may find it easier to change the name of the inputs and outputs to something more suited to their installation. For example, instead of output 1, you may want to change the title to "Receiver A."

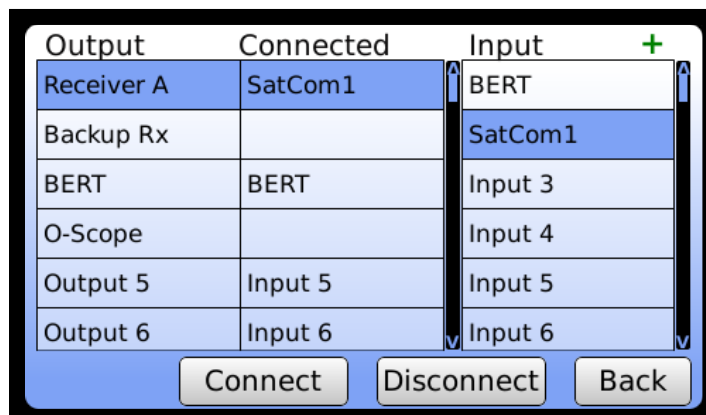

To change the name of a specific input or output, simply press and hold the title for three seconds then edit the name with the on-screen keyboard that appears. These names may also be changed remotely using the LOUT and LIN functions described in Sections 5.3.31 and 5.3.32

Note that there is a ten character maximum for custom labels and restricted characters are the quotation mark, comma, and semicolon.

2.12.3. Signal Detect

Some Universal Switching system models include active signal detection features on the inputs and outputs of the switch matrix. When available, the View Connections screen will indicate I/O's with active signal detected via a + sign to the right of the I/O as shown in the diagram below.

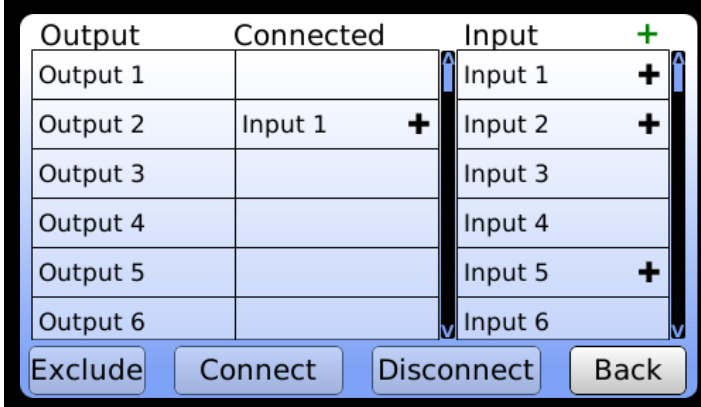

The screenshot shows a table with four columns: Output, Connected, Input, and a signal detection indicator (+). The table lists six outputs and six inputs. Output 2 is connected to Input 1, and both have a '+' sign indicating active signal detection. Output 5 and Input 5 also have a '+' sign. The table is surrounded by a scrollable area with vertical arrows. Below the table are four buttons: Exclude, Connect, Disconnect, and Back.

Output	Connected	Input	+
Output 1		Input 1	+
Output 2	Input 1	Input 2	+
Output 3		Input 3	
Output 4		Input 4	
Output 5		Input 5	+
Output 6		Input 6	

2.13. Signal Exclusions

On Tri-Stage products, any given input to output may be processed through a number of mid-stages. If the signal performance is undesirable and a different mid-stage a preferred, the Exclude function can be used to prevent the I/O from being routed through the mid-stage currently in use.

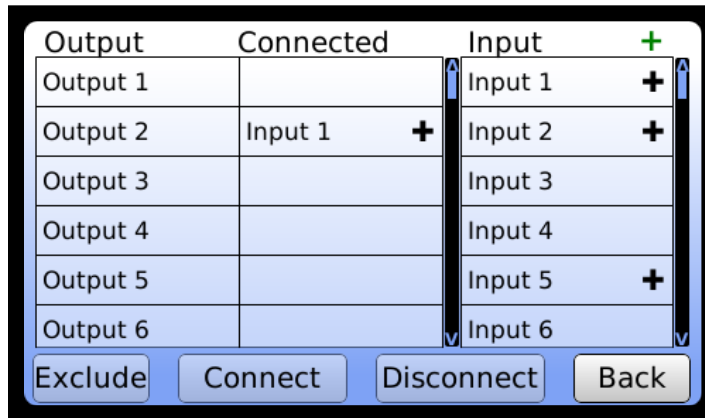

When the Exclude button is pressed, a warning dialog will be produced:

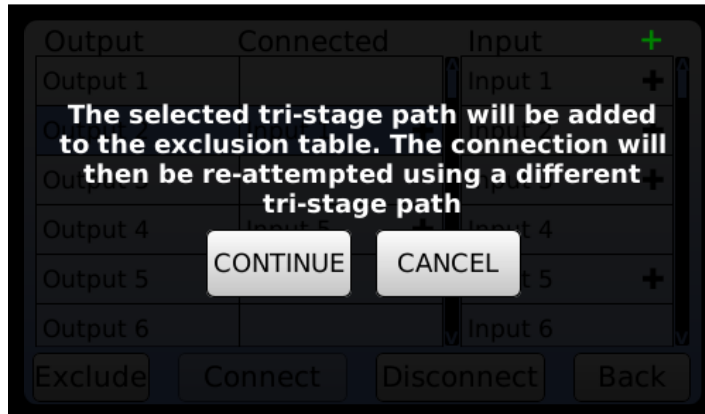

Access to the Exclusion Table is through the System Functions menu (See Section 2.14.2) by pressing the View Exclude Table button.

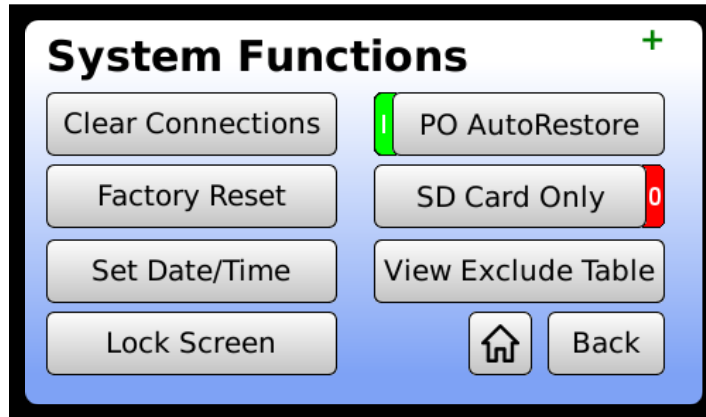

Once accessed, you can undo an exclusion by pressing the INC (include) button, clear all of the exclusions by pressing the Clr Table button, or perform a SCAn All function (See Section 5.3.1.7. for details.)

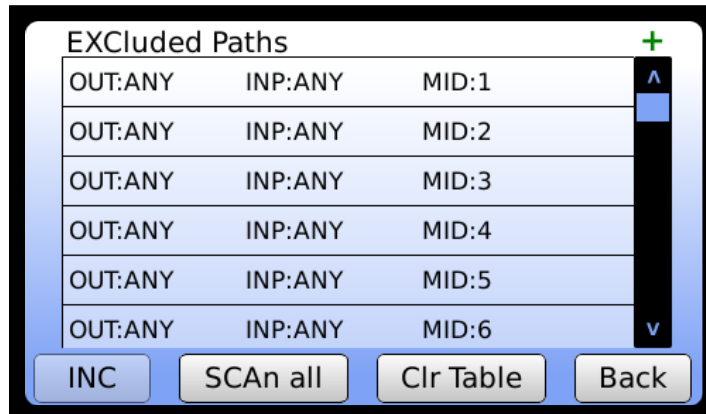

2.14. Menu

The Main Menu contains a series of sub-menus that are summarized in Section 2.2. Each menu will have a button in the lower right corner that depicts a house. This button is considered the home button and will bring you back to the Home Screen (Section 2.3)

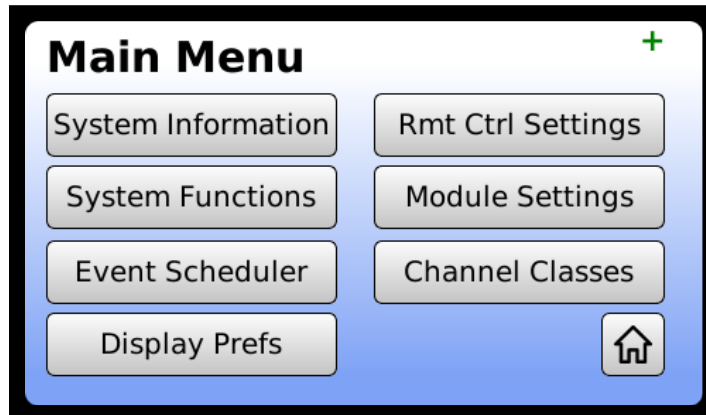

2.14.1. System Information

The system information sub-menu contains read-only information pertaining to the system. The details of which are outlined below.

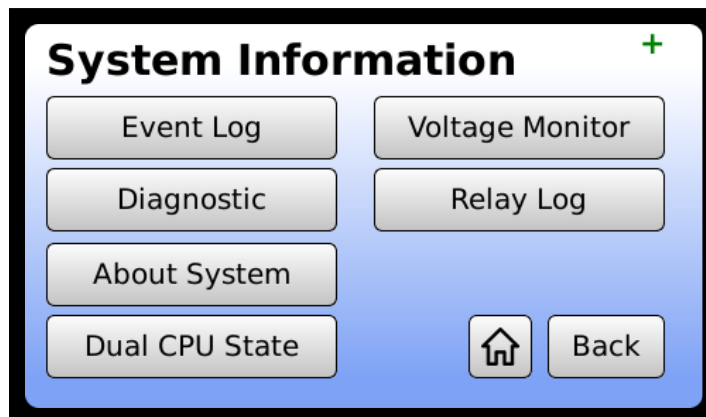

2.14.1.1. Event Log

The event log tracks all activity from any of the remote interfaces, web GUI, and front panel touchscreen display. Events are timestamped and show the command or query and results.

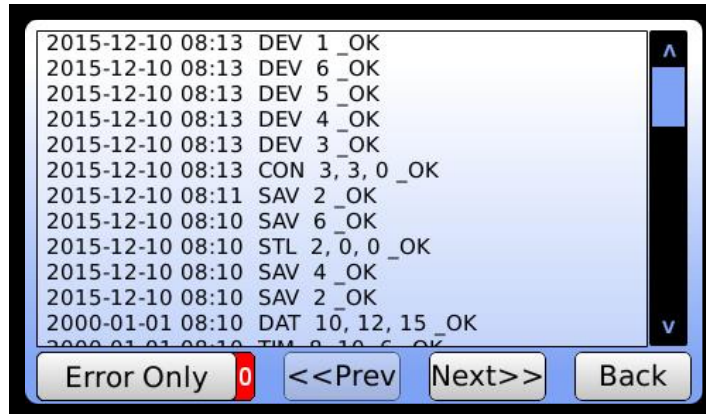

The Error Only button is a Boolean toggle that is either ON (green / 1) or OFF (red / 0). By toggling this function ON, you can filter out all events except for those that resulted in an error:

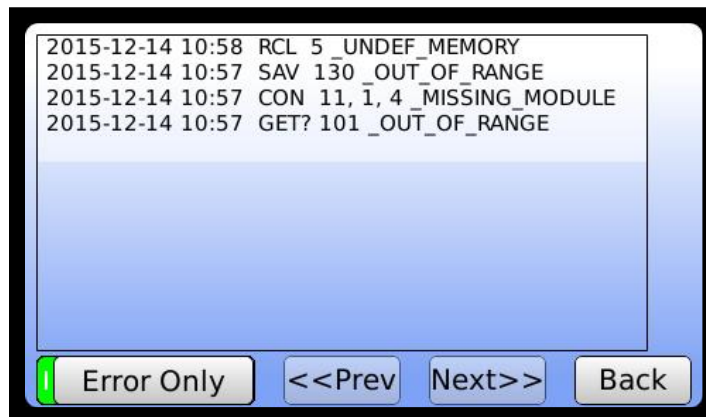

The event log is also accessible from the Web GUI. Please see Section 5.3.35 and 9.7 for details.

2.14.1.2. Diagnostic

The default view of the Diagnostic screen shows the current module population. Empty, non-operational, or non-recognized modules are shown with a dash (-). Modules that the CPU expects to be installed but are not detected are designated with an "X". Expected and installed modules are shown in order from top to bottom with their accompanying slot number.

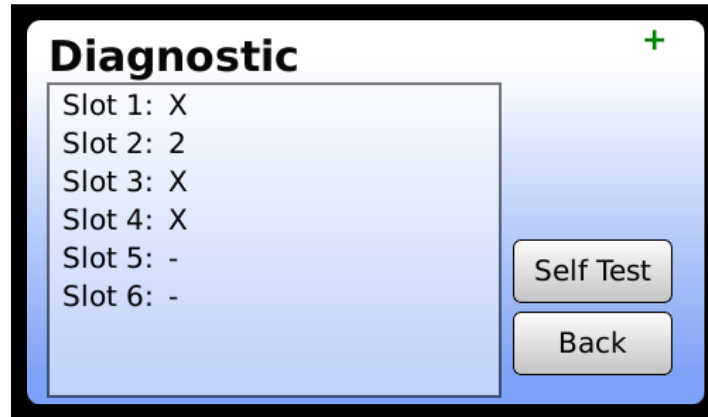

2.14.1.2.1. Self Test

If selected, a self-test will be executed. The display will flash "Updating List..." while the self-test is being processed. The results of the self-test are then displayed. This function should be used after any hot-swapping actions have been done with the power supply, switch or CPU modules.

2.14.1.3. About

The About Unit screen includes information about the firmware, system MAC address and custom user description which may be changed from the web GUI.

System F/W: System firmware model number – revision code

Display F/W: Display firmware model number – revision code

MAC Address: MAC address of the CPU

User Description: User defined description of the system that can be changed from the web GUI. By default, it is the same as the System Description.

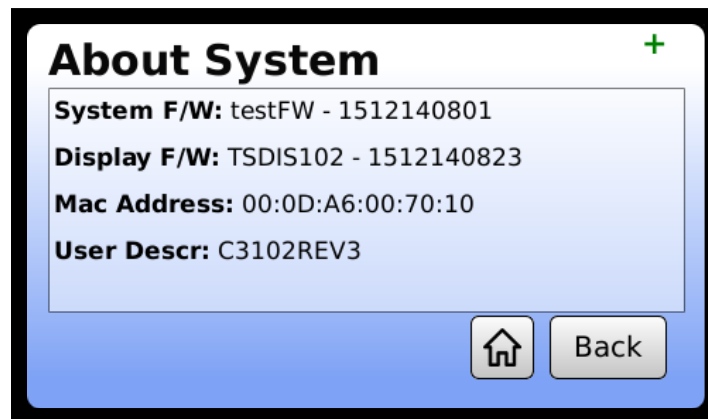

2.14.1.4. Dual CPU State

Pressing this button will bring you back to the home page where the Dual CPU status will be shown. If there are two CPU's installed, it will show which is the primary (Top or Bottom).

2.14.1.5. Voltage Monitor

When selected, the voltage menu will appear. This screen shows the status of the power supply voltages in the system. It is divided into three columns including the Main, PSU1 and PSU2.

Main: This is the voltage level as seen from the CPU processor (after the diode). It is a combination of voltages in redundant systems.

PSU1: This is the voltage being read by the power supply monitoring board in Power Supply 1. (before the diode)

PSU2: This is the voltage being read by the power supply monitoring board in Power Supply 2. (before the diode). Note that in single supply systems, these values will be zero.

The PS1 and PS2 buttons allow for turning the active power supply monitoring function on or off. This may be used in cases where a system programmed for redundant power supplies has only one power supply installed. By turning the monitoring off for the missing supply, you avoid receiving power supply missing faults and error indicators on the front panel.

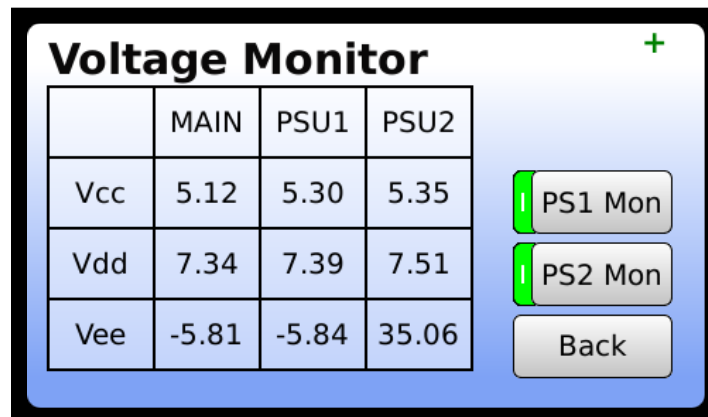

Power Supply monitoring may be disabled by toggling the PS1 Mon button for power supply 1 or the PS2 Mon button for power supply 2.

2.14.1.6. Relay Log

In systems that utilize electro-mechanical switches with a finite life span or cycle count, the system will show a Relay Log. This log's the contacts of relays in the system. This information can then be used to identify relays that are approaching the end of their life span and should be considered for replacement. As the life span of relays may vary depending on the model, consult the Operations Manual for your specific system to determine the life span specification of the relays.

If a relay has been replaced, you can reset the count via the web GUI. See Section 9.9 for more details.

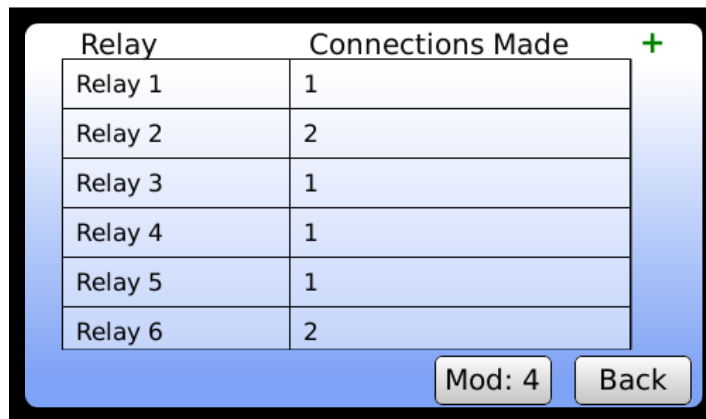

Relay	Connections Made
Relay 1	1
Relay 2	2
Relay 3	1
Relay 4	1
Relay 5	1
Relay 6	2

Mod: 4 Back

2.14.2. System Functions

The system functions sub-menu contains customizable settings pertaining to the system. The details of which are outlined below.

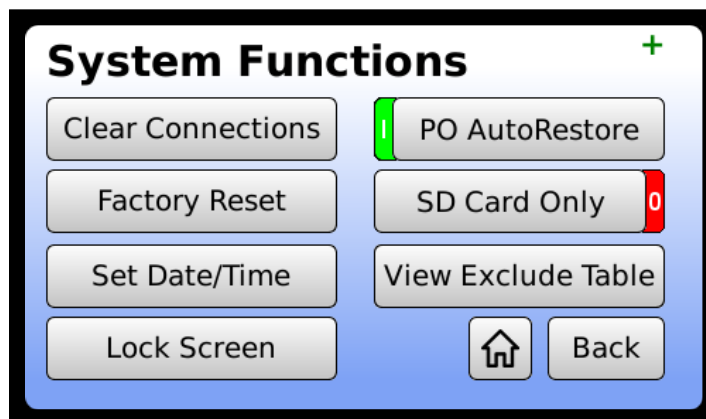

System Functions

Clear Connections PO AutoRestore

Factory Reset SD Card Only

Set Date/Time View Exclude Table

Lock Screen Home Back

2.14.2.1. Clear Connections

This function will clear all of the crosspoints on the system. You will be prompted to confirm this action or cancel.

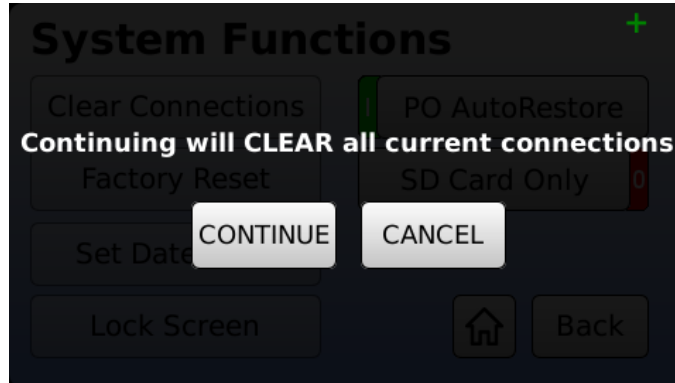

2.14.2.2. Factory Reset

You may use this button to restore the system to factory default settings. You will be prompted for the factory reset code: **7671**



After successfully entering the code and pressing Enter, you will be prompted to confirm the factory reset.

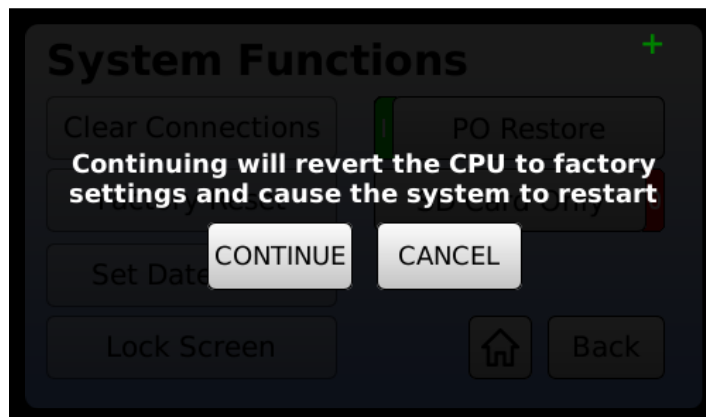

2.14.2.3. Set Date/Time

Use the scroll wheels to set the current date and time for the real time clock functions. Additionally, the unit may be set to synchronize with an NTP server via the web interface. See Section 9.3 for details.

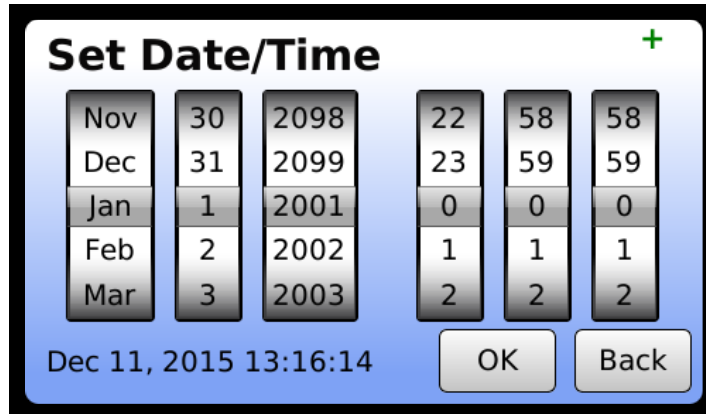

2.14.2.4. Lock Screen

The front panel controls may be locked by the user to avoid unintentional configuration changes. To lock the front panel, punch in a lock code then press Enter. Valid lock codes are anywhere from 0001 to 9999.

Once the front panel is locked, it must be unlocked before regaining access. Note that remote control access is always available regardless of the status of the lock screen.

NOTE: If the security code is unknown, press LCL, enter 7145, and press ENT on the keypad to unlock it.

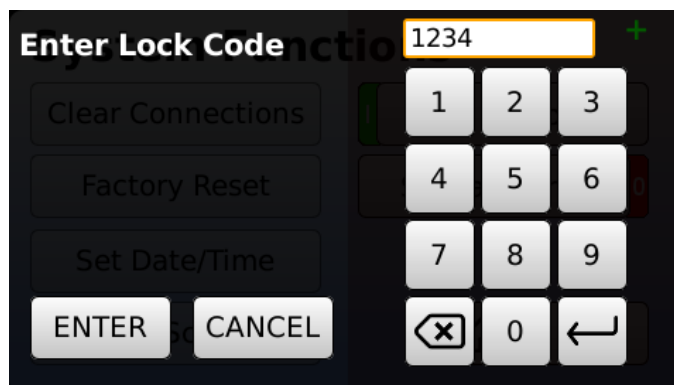

2.14.2.5. PO AutoRestore

Short for Power On Auto Restore, this parameter may be enabled (On) or disabled (Off). When enabled, the unit automatically restores the last configuration from before the unit was powered OFF (or power was lost to the unit). When disabled, all cross-points are automatically cleared on power ON. To change the setting, tap the Boolean toggle to the On or Off positions.

NOTE: The factory default is Power On AutoRestore enabled (On), so that the unit is returned to the last known cross-point state when powered ON.

2.14.2.6. SD Card Only

The system may optionally store configuration data and settings on an SD card, internal serial flash, or both. When the toggle is set to ON, the setting is in SD Card Only mode. When the toggle is set to OFF, the setting is in Redundant Mode. See Chapter 0 for more details.

The SD Card icon is shown in the top right corner of the display. The following table defines the color status:

Color	Definition
Black	Redundant mode with SD card present
Red	SD Only mode with SD card missing
Green	SD Only mode with SD card present

NOTE: The factory default is Redundant Mode(SD Card Only = Off). Lack of an SD Card icon on the display indicates that the system is in Redundant mode and an SD card is not present.

2.14.2.7. View Exclude Table

See Section 2.130 .

2.14.3. Event Scheduler

The Event Scheduler allows the operator to schedule a recall of a pre-saved crosspoint configuration index number (See Section 2.11 on storing / recalling configurations). The scheduler is accessed through the main menu or from the web GUI.

Events can be scheduled every 30 minutes over a 24 hour period. Events can be flagged to repeat every day or not. In the example below, "MISSION 1" is scheduled to be recalled every day at midnight. "Memory 3" will be recalled at 12:30am but only once and then the event will clear from the scheduler. At 1:30am, "SETTING" will be recalled and then the event will clear from the scheduler.

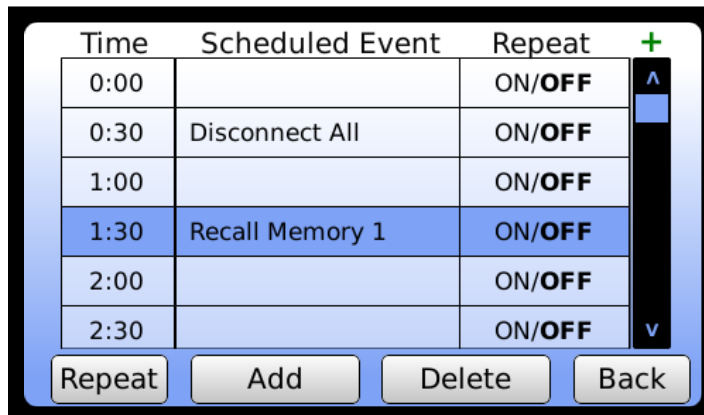

Time	Scheduled Event	Repeat	+
0:00		ON/OFF	▲
0:30	Disconnect All	ON/OFF	
1:00		ON/OFF	
1:30	Recall Memory 1	ON/OFF	
2:00		ON/OFF	
2:30		ON/OFF	▼

Repeat Add Delete Back

To add a new event to the scheduler, press the Scheduled Event box next to the corresponding time slot. A keypad menu will appear where you can enter the memory index number for the configuration you want recalled. Simply press the corresponding ON/OFF button to toggle the repeat function of the event. You may also enter a value of 0 to schedule a "Disconnect All" event where all crosspoints will be cleared.

2.14.4. Display Preferences

In the Display Preferences menu, you may adjust the backlight brightness and background color from the available options. If required, the display firmware may also be updated from this menu. Contact the factory for additional details.

The screen saver function will dim the display after 5 minutes of no activity. The default state for this function is ON. To turn it off, tap the Boolean toggle switch to OFF.

2.14.4.1. Beep On Error

The unit has an internal beeper to indicate an error. This assists the user during firmware development and alerts the user of equipment failure. The unit also has a RED front panel indicator labeled that illuminates during an error condition.

NOTE: The factory default is Beep On Error enabled (On).

To change the setting, tap the Boolean toggle to the On or Off positions.

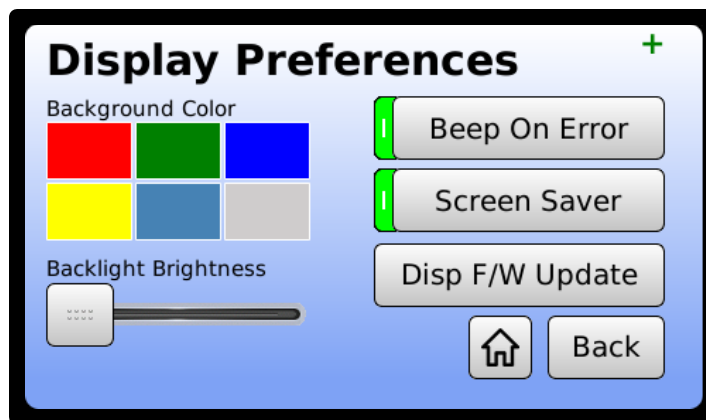

2.14.4.2. Display Firmware Update

Occasionally, the display firmware may require an update. This firmware is field updateable using a microSD card or USB drive. The firmware file will be provided by the factory.



2.14.5. Remote Ctrl Settings

This Remote Control Settings sub-menu contains all of the settings for communicating with the unit over a remote interface including Serial, Ethernet, and USB.

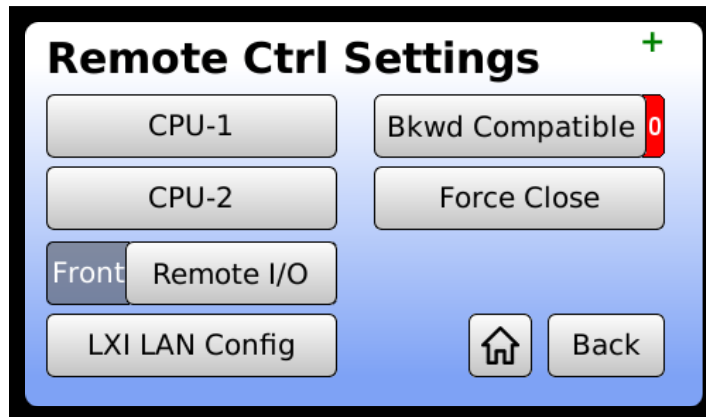

2.14.5.1. CPU-1 / CPU-2

This is where the Ethernet and Serial communication ports are configured. For systems with dual redundant CPU's, The CPU-1 and CPU-2 menus are identical but independent of each other.

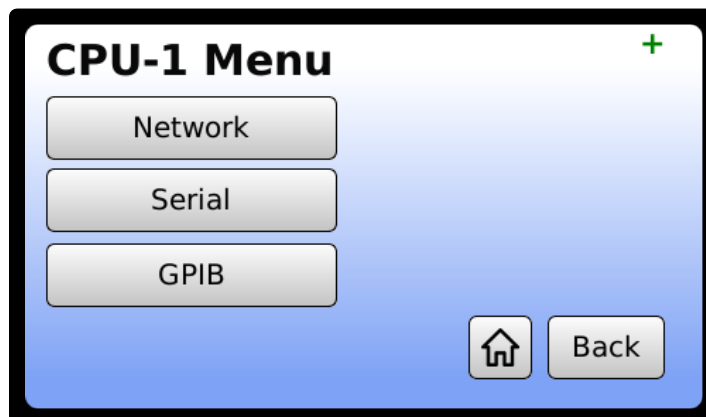

2.14.5.1.1. Network

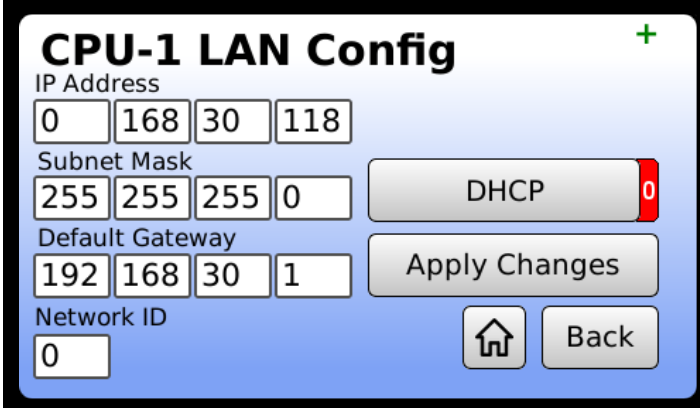

IP Address: If a static IP address is to be used, enter it here. Otherwise a DHCP address will be used.

Subnet Mask: Enter the subnet mask of your LAN

Default Gateway: Enter the default gateway of your LAN.

Network ID: Default number is "0" and is used to distinguish two systems that have the same product code. This number is also the alpha code for the Serial RS-485 address where Network ID "1" makes RS-485 address "A".

DHCP: This button will toggle the DHCP function to ON or OFF depending on your network configuration. Contact your network administrator for details.

Apply Changes: Press the Apply button to lock in the Ethernet settings. This will take you back to the Home screen. The message Force Close...Please Wait will be displayed in the Last Action Window while the system is updating.

2.14.5.1.2. Serial

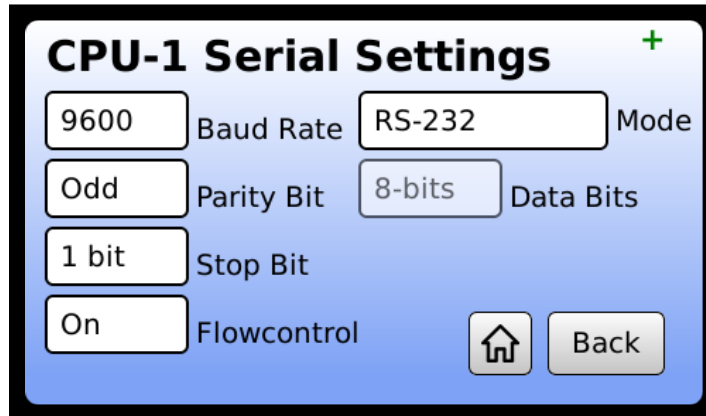

The serial settings menu allows you to configure the serial port to match the serial settings of your host. By pressing any of the available settings, a drop down menu will be activated. Use your finger to scroll through and select the appropriate settings for your environment. Available options are:

Baud Rate	2400
	4800
	9600
	19200
	38400
	57600
	115200
Parity	None
	Odd
	Even
	Mark
Stop Bit	1 Bit
	2 Bit
Flow control	Off
Data Bits	8-Bits
Mode	RS-232
	RS-485 w/ Termination
	RS-422
	RS-485
	RS-422 w/ Termination

2.14.5.1.3. GPIB

The GPIB menu allow you to set the GPIB address when using the optional GPIB-USB-006 USB to GPIB adapter. Note that the USB port on the C3 CPU must be configured to accept the GPIB adapter See GET? / SET value 75 and 76 in Section 5.5 for details.

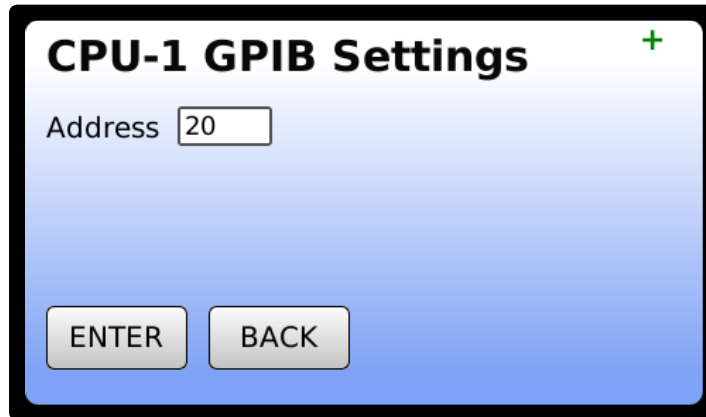

2.14.5.2. Remote I/O

In the 2RU mainframe, the C3-001 CPU is installed in the front of the chassis. The I/O (Ethernet, Serial, USB) is routed to the rear of the system by default and the I/O connectors on the front of the CPU are disabled. You may enable the front facing I/O connectors and disable those on the back of the mainframe by toggling this setting. Note that this is only available for the 2RU mainframe and will be greyed out for all other size mainframes as the CPU's are installed in the rear of the chassis.

2.14.5.3. LXI LAN Config

Pressing this button will reset the LAN interface for both CPU's (if redundant) into a known state per LXI requirements. You will be prompted to confirm with the following screen:

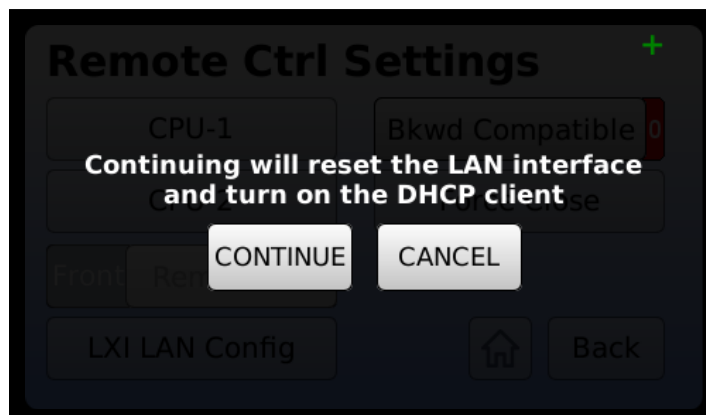

2.14.5.4. Bkwd Compatible

Short for Backwards Compatibility Mode, this Boolean toggles the remote control mode, see Section 5.1 for more details.

Backwards Compatibility is either on or off. When it is ON, the system is using the **US**, MSC, or other custom control protocol. Consult the system Operations Manual for more details.

When the mode is OFF, the system is using the IEE 488.2 compliant command set which is outlined in Section 5.3

2.14.5.5. Force Close

The force close function closes all open TCP/IP sessions so that a new session may be opened. See Section 5.3.11 for more details.

2.14.6. Module Settings

Module settings are those that apply to the switch matrix inputs and outputs. These optional settings are described below.

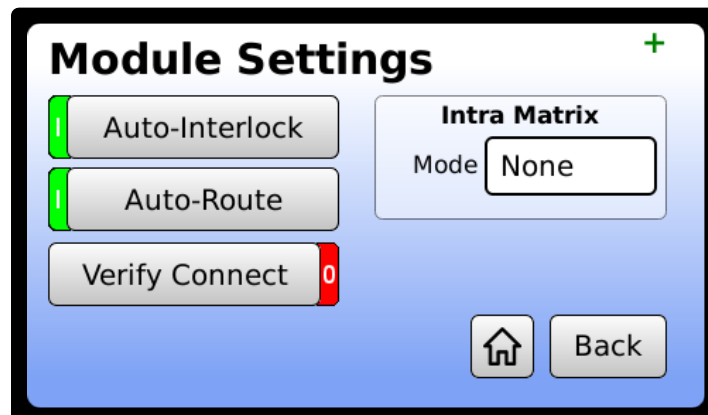

2.14.6.1. Auto-Interlock

Two (2) modes of "AUTO INTERLOCK" control are available. With the Auto-Interlocking feature enabled (On), the unit automatically disconnects any input connected to the specified output port (or relay port) before making the new input connection.

With the input Auto-Interlocking feature disabled (Off), the user must send a disconnect command for the existing cross-point connection (or relay port connection) prior to connecting any new input port.

To change the setting, tap the Boolean toggle to the On or Off positions.

NOTE: The factory default is Auto-Interlock mode enabled (On).

2.14.6.2. Auto-Route Mode or Ganged Mode

Depending upon the system requirements, the system may be enabled in either "AUTO-ROUTE" mode or "GANGED" mode.

The AUTO-ROUTE mode routes the connection command without the need to address a specific module number. Tri-Stage™ or Output End-to-End systems are configured in AUTO-ROUTE mode.

GANGED mode groups two or more switch matrices into a single matrix, simplifying the control scheme. This is ideal for clock/data applications. Ganged modules are called "virtual poles" and are treated by the system as a virtual module. See Section 6.2.3 for more details.

2.14.6.3. Verify Connect

If available, the Verify Connect toggle will use the CVE? query instead of the standard CONnect command to connect crosspoints. See Section 5.3.1.8. for more details on this query.

2.14.6.4. Intra Matrix

C3 compatible systems are capable of internally ganging input and output pairs for synchronous clock/data applications within a single switch matrix. This feature allows for a single command (via front panel or remote interface) to control two crosspoints simultaneously. There are two different approaches for internally ganging input and output pairs:

- **Series Ganging**

In this mode, the software "Input 1" translates to the hardware inputs 1 and 2. "Input 2" translates to inputs 3 and 4. This pattern continues for the full size of the matrix. This operational mode is ideal to maintain maximum propagation delay matching between clock and data pairs.

- **Parallel Ganging**

In this mode, the matrix is divided in two where a normal 32x32 matrix now becomes two sections of 16x16. The software "Input 1" translates to the hardware inputs 1 and 17. "Input 2" translates to inputs 2 and 18. This pattern continues for the full size of the matrix. This operational mode provides an additional option for the end user and may be preferred to the series ganging approach depending on the users installation and application use.

To enable the Intra Matrix, select the module ID from the available list (tap the Module field), then set the mode to be applied to that module.

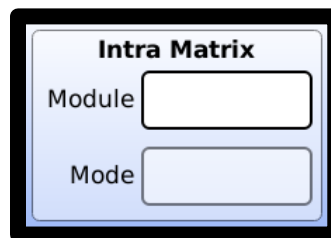

The image shows a screenshot of a web GUI configuration page titled "Intra Matrix". It contains two input fields: "Module" and "Mode". The "Module" field is currently empty, and the "Mode" field is also empty. The background of the form is light blue.

You may also enable the settings on the Switch State page in the web GUI. See Section 9.5 for more details.

2.15. Channel Classes

Classing is a feature that allows the user to assign inputs and outputs to one or many classes where only similarly classed I/O's can be connected. This feature is useful for applications where only a specific set of inputs will only ever connect to a specific set of outputs and any deviations could have adverse results.

There are 32 available classes which are identified using their class index number: 1 – 32. By default, all I/O's are assigned class 0 (or Global) which allows for global access within the matrix.



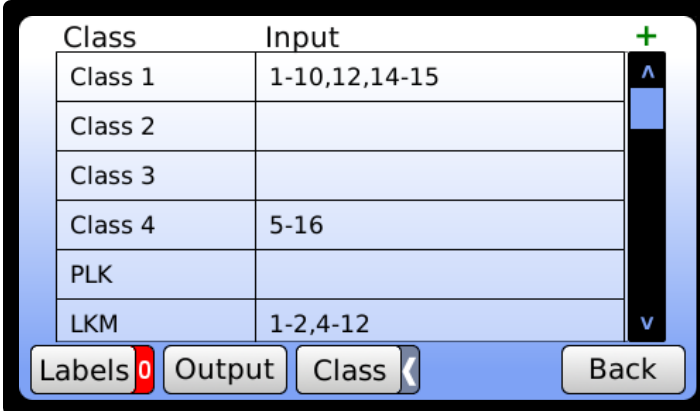



The default view shows the class list on the left and the associated inputs on the right.



Class	Input
Class 1	1-10,12,14-15
Class 2	
Class 3	
Class 4	5-16
PLK	
LKM	1-2,4-12

Labels 0 Output Class < Back

The following toggle's are available:

-  Labels 0 Labels off. Press to show custom I/O labels.
-  Labels 1 Labels on. Press to show I/O numbers.
-  Output Press to show outputs instead of inputs.
-  Input Press to show inputs instead of outputs.
-  Class < Class View. Currently lists each class with associated I/O. Press to list each I/O with associated class instead. (I/O View).
-  Class > I/O View. Currently lists each I/O with associated class. Press to enter class view.

2.15.1. Class Editor

There are two methods of assigning classes to I/O's which depend if you are using the Class View or I/O View. This section will discuss both options.

2.15.1.1. Class View

While in class view **Class**, press and hold the class you wish to edit. This will bring up the Class View editor. Note that if you were viewing associated outputs on the previous screen, the editor will display the output list. To view inputs associated with the class, go back and switch to inputs.

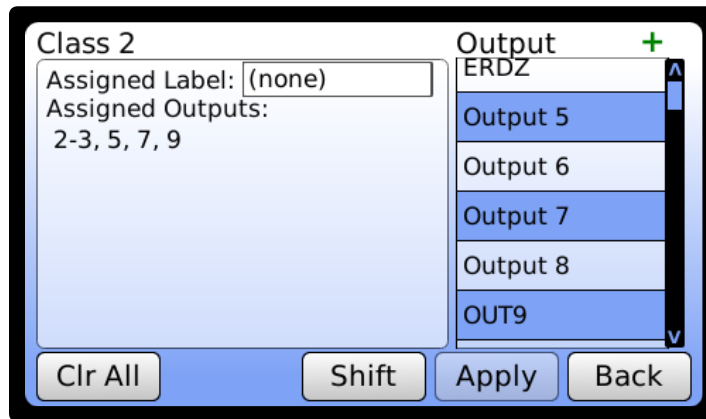

The example above shows that Class 2 currently does not have a custom label associated with it (none). You can tap the field to add a label with the on-screen keyboard. We also see that outputs 2-3, 5, 7 and 9 are assigned to Class 2. By tapping on the outputs on the right, you can add or remove outputs from Class 2. You can also use the shift button to select a range of outputs.

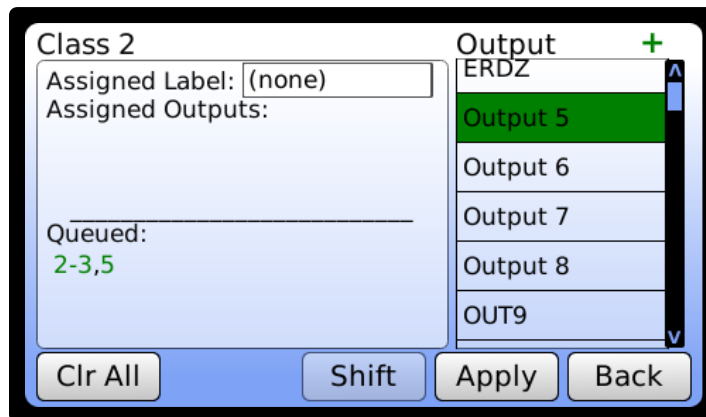

As you tap outputs, they will be added to the queue. Outputs in green will be added while those in red will be removed from the class. Changes do not take effect until the Apply button is pressed.

2.15.1.2. I/O View

While in I/O view , the I/O's are shown on the left while their associated classes are displayed on the right.

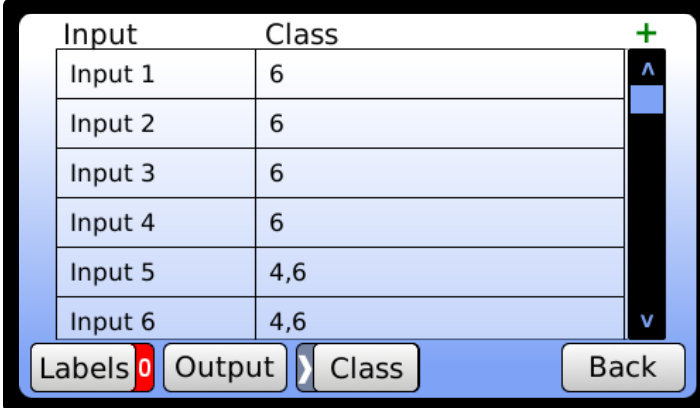

Input	Class
Input 1	6
Input 2	6
Input 3	6
Input 4	6
Input 5	4,6
Input 6	4,6

At the bottom of the screen, there are four buttons: "Labels" (with a red '0' indicator), "Output", "Class" (with a right-pointing arrow), and "Back".

Press and hold the I/O you wish to edit. This will bring up the I/O View editor:

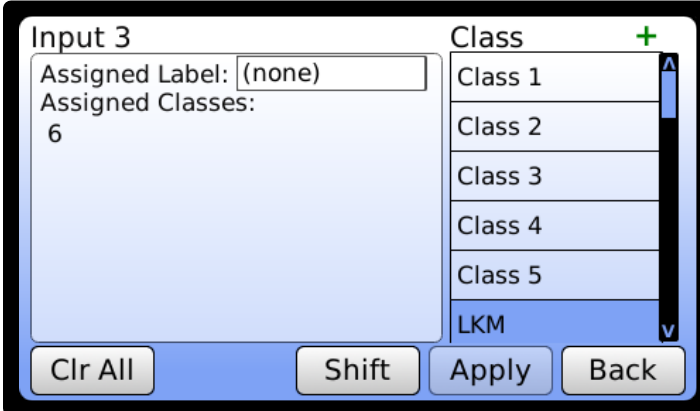

Input 3

Assigned Label:

Assigned Classes:
6

Class

- Class 1
- Class 2
- Class 3
- Class 4
- Class 5
- LKM

At the bottom of the editor, there are four buttons: "Clr All", "Shift", "Apply", and "Back".

The example above shows that Input 3 currently does not have a custom label associated with it (none). You can tap the field to add a label with the on-screen keyboard. We also see that it is assigned to class 6. By tapping on the available classes on the right, you can add or remove classes to input 3.

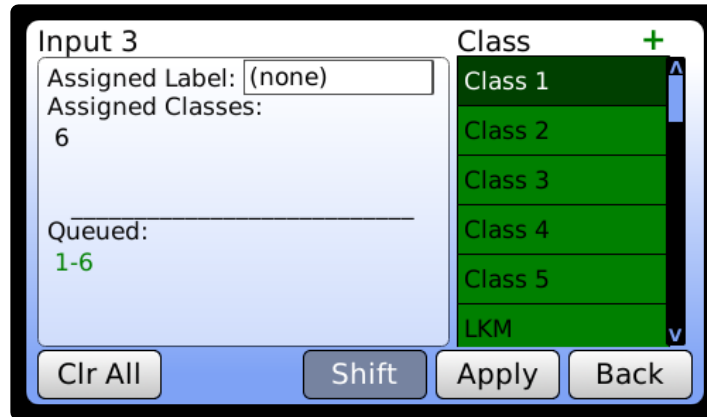

2.16. LAN Status Indicator

The LAN Status Indicator (LSI) is shown in the top right corner of the display and provides multiple functions:

2.16.1. Front Panel ID

When the Front Panel ID mode is enabled via the web interface (See Section 9.1) or via remote GET?/SET value 84 (See Section 5.5), the LSI will flash on and off. This allows a remote control user of the device to determine which device is being communicated with if they are in an environment with multiple devices of similar model or appearance.

2.16.2. LAN Status

The LAN Status Indicator can be used by the operator to identify a problem with the Ethernet control. The indicator may either be a green plus sign (+) or a red exclamation point (!). They are defined as follows:

- + Ethernet control is operational, no problem detected.
- ! Problem detected

Possible reasons for an exclamation point are:

- Failure to acquire a valid IP address
- Detection of a duplicate IP address
- Failure to renew an already acquired DHCP lease
- LAN cable disconnected

2.17. Master / Remote

In specific systems, a mainframe may be designated “Master” while others are designate “Remote(s)”. The user commands the master and the master communicates to the remotes.

When a system is designated a master, it will show a red M in the top right corner of the display per the example below:

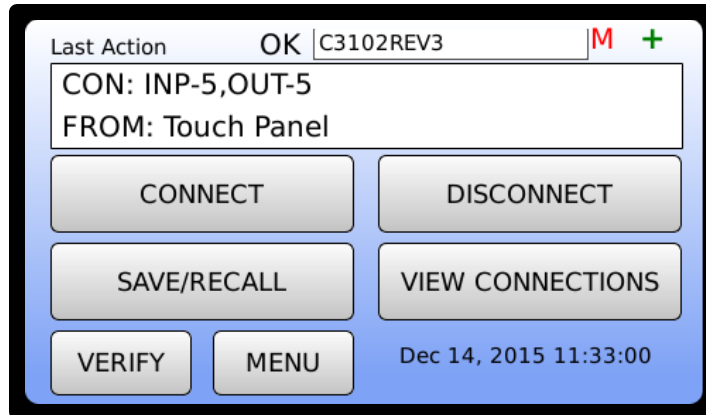

2.18. Remote Control via RouteWarePRO

When the system has an active session with RouteWarePRO (See Section 12.1 for details), the RouteWarePRO shield will be blinking in the top right corner of the display.

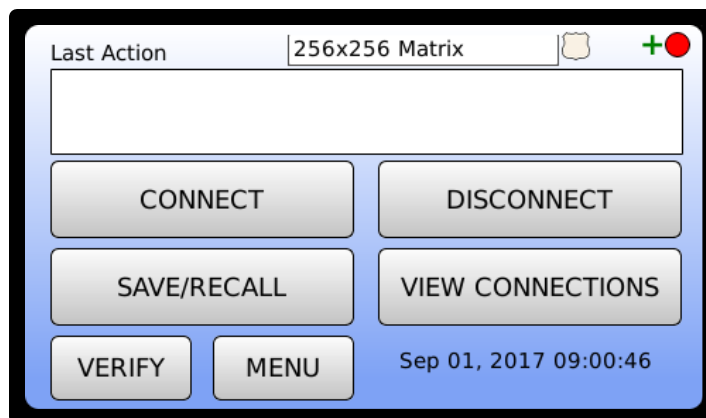

**THIS PAGE WAS
INTENTIONALLY LEFT
BLANK**

3. 10.1” Front Panel

A 10.1” version of our GUI is available on the S2561FX and S2560FX high-density Tri-Stage™ switching products. The 10.1” GUI includes all of the same menus and features previously discussed in this manual. However, the larger size allows for an advanced X-Point viewer for our larger switch matrices. This section describes the additional features of the 10.1” display.

Note that functions which are identical to that specified in Chapter 2 are simply referenced and not repeated in this section. The video below shows a brief introduction to the touchscreen interface that is described throughout this manual section.

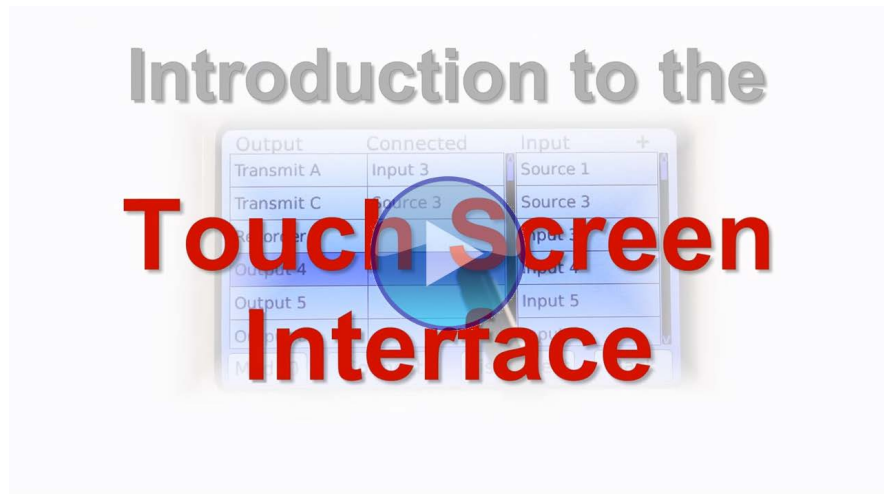

3.1. Menu Tree

The diagram below illustrates the various menus and functions available on the front panel touchscreen display.

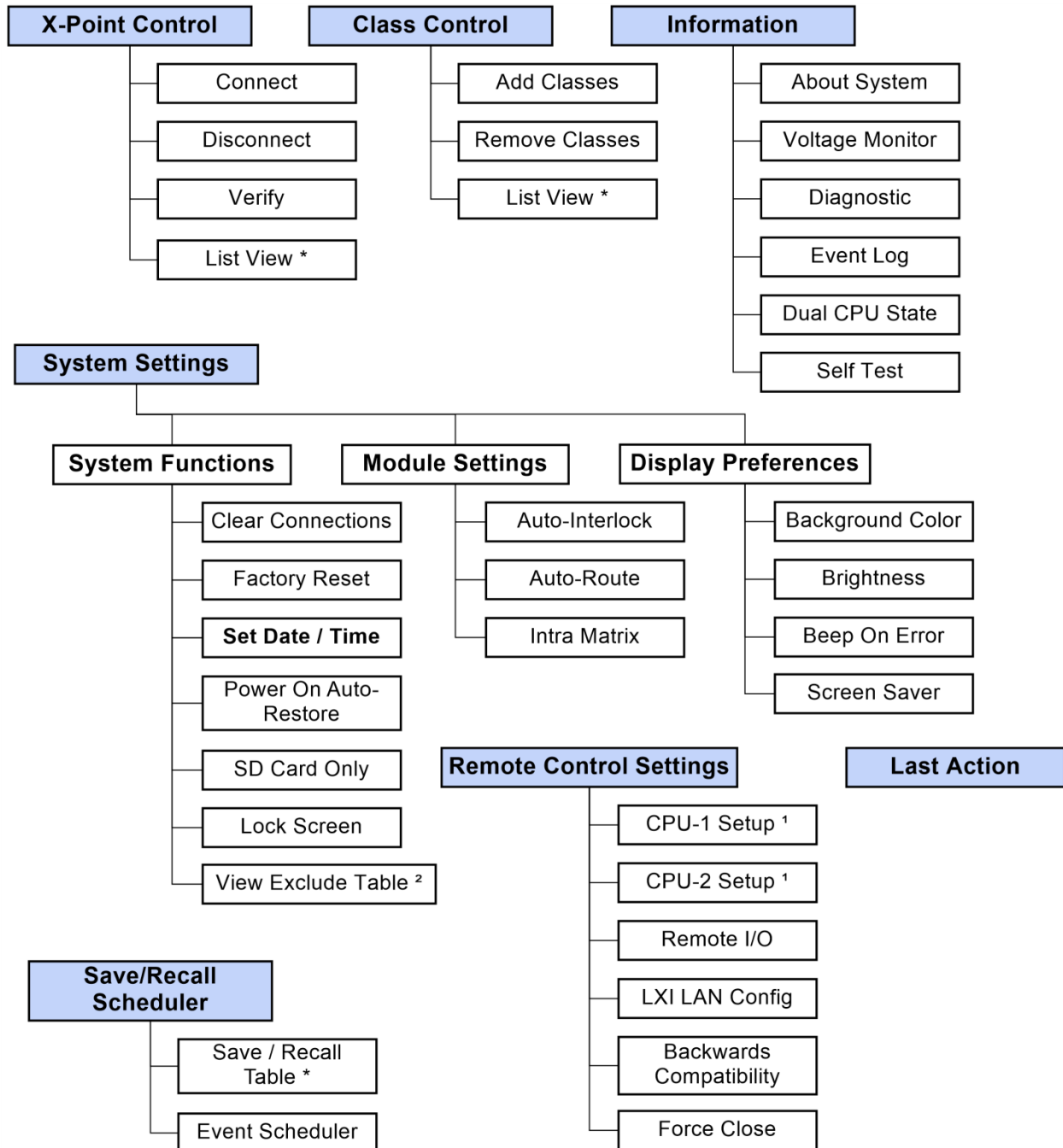

* You may apply a custom label directly from this screen

1 Setup includes IP address, DHCP mode, Serial baud rate, etc.

2 Only available on Tri-Stage™ systems

3.2. Local Lock

The local lock feature will lock out the front panel, preventing any un-intentional configuration changes. The screens may be viewed but not changed. By pressing the Local Lock button, you will be prompted to enter a lock code. This code must be four digits and range from 0001 to 9999.

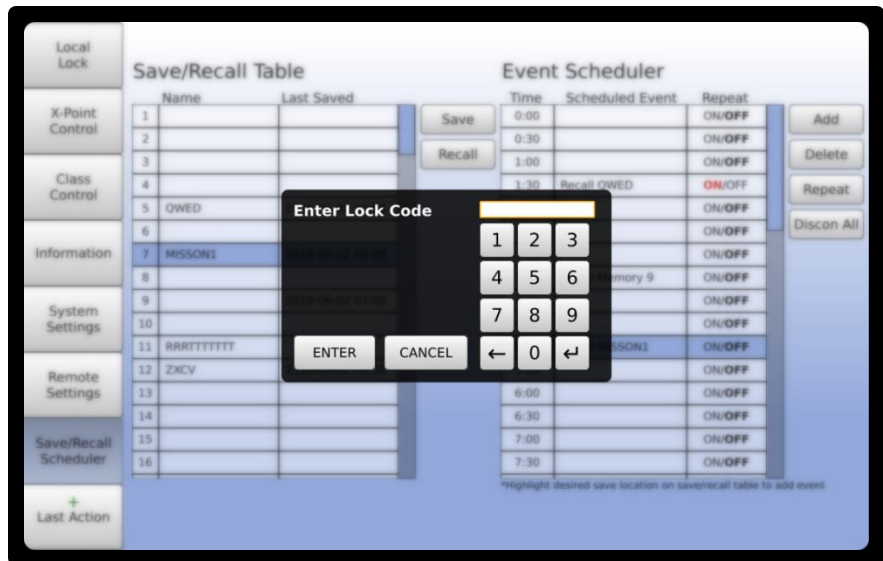

As shown below, when the panel is locked a red dash line will be shown at the top of all screens and the Local Lock button will turn red.

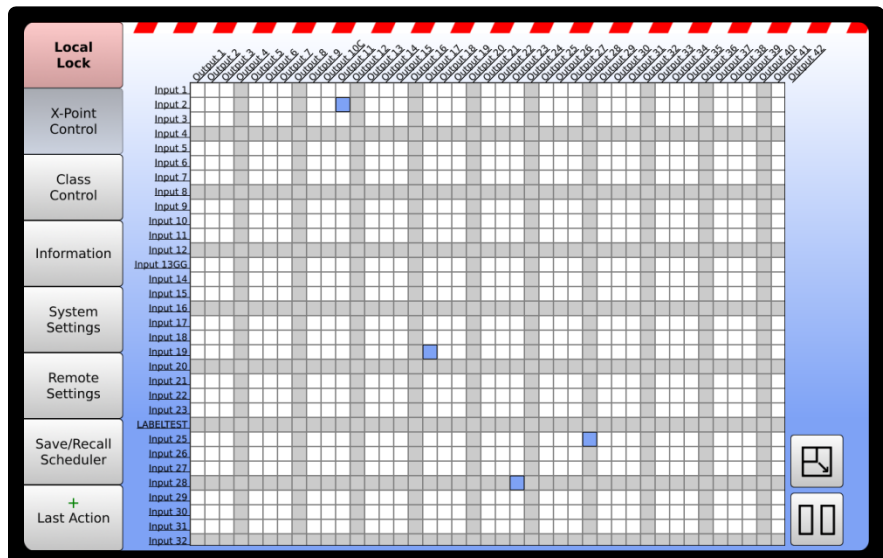

Once the front panel is locked, it must be unlocked before regaining access. Note that remote control access is always available regardless of the status of the lock screen.

NOTE: If the security code is unknown, the backdoor default code is 7145.

3.3. X-Point Control



The X-Point Control menu provides a graphical representation of the crosspoint status and allows for advanced control of the matrix. This section describes the various screens and functionality of the X-Point Control menu.

3.3.1. Overview

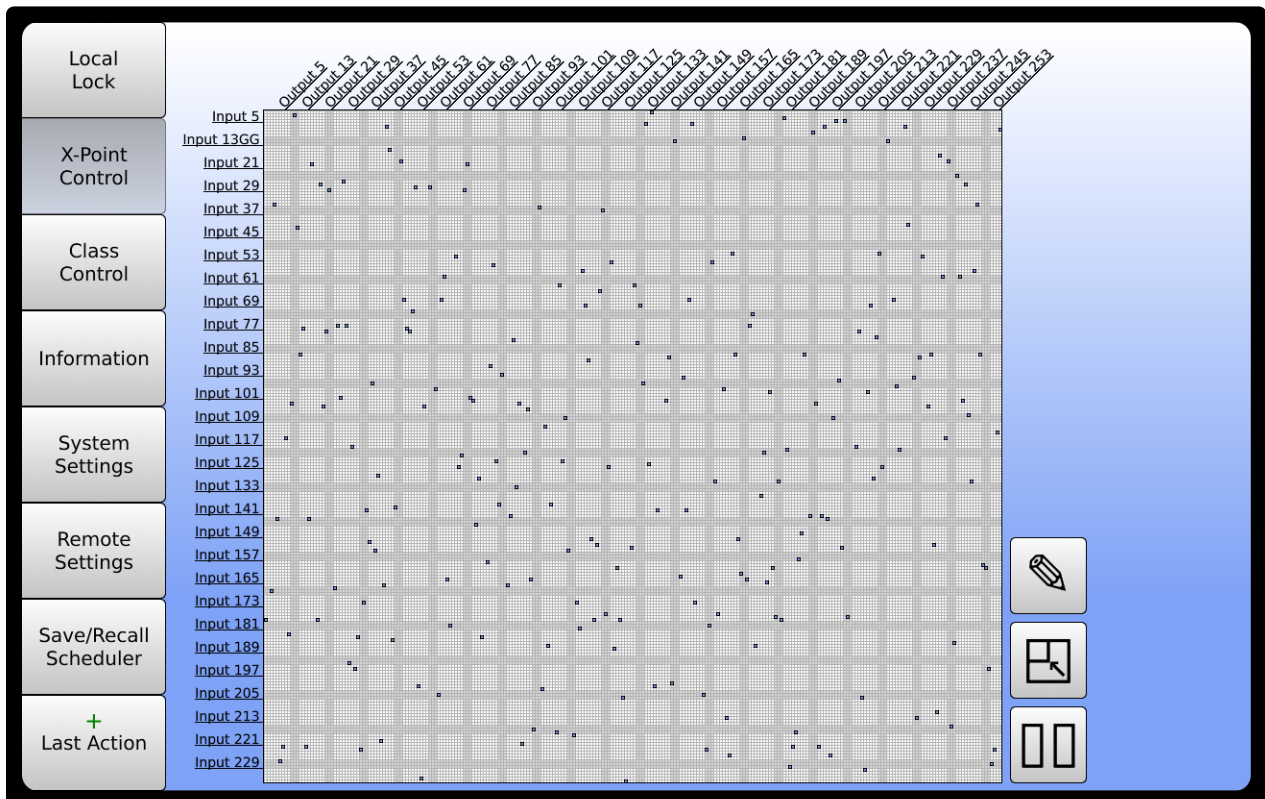
The Overview screen shows the entire matrix. You may access the crosspoint editor, navigator or list view. Note that if the intra-matrix is enabled, you may only see half of the matrix. See Section 3.6.2.3. for details.



3.3.2. Crosspoint Editor

From the Overview screen, tap on the general location of the crosspoint you want to edit then select the editor icon: . This will bring up the editor window which displays a 16x16 section of the matrix with crosspoint control. You may press the  icon to zoom out and access another section.

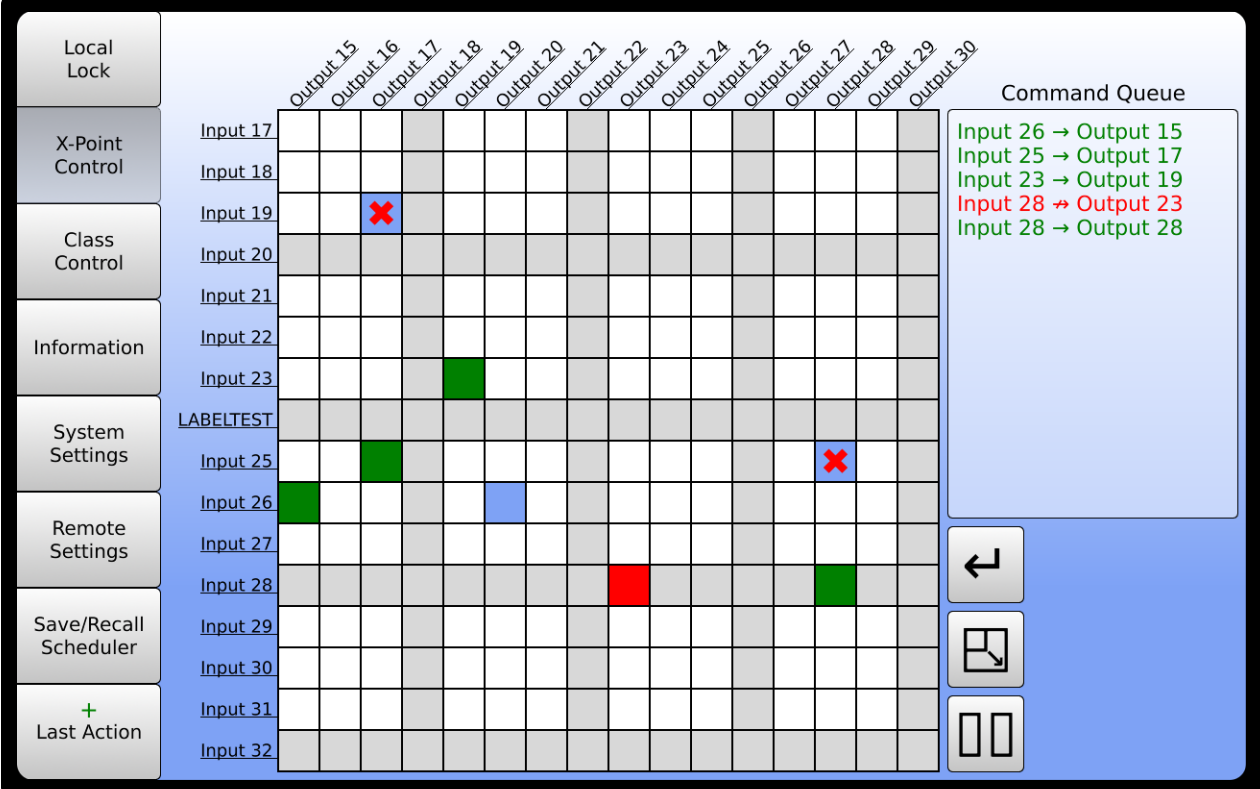

The screenshot shows the Crosspoint Editor interface. On the left is a vertical menu with options: Local Lock, X-Point Control, Class Control, Information, System Settings, Remote Settings, Save/Recall Scheduler, and + Last Action. The main area is a 16x16 grid with columns labeled Output 15 through Output 30 and rows labeled Input 17 through Input 32. The grid contains several colored squares: a red 'X' at (Input 19, Output 16), a green square at (Input 23, Output 18), a green square at (Input 25, Output 16), a blue square at (Input 26, Output 19), a red square at (Input 28, Output 22), and a green square at (Input 28, Output 27). To the right of the grid is a Command Queue with the following entries: Input 26 → Output 15, Input 25 → Output 17, Input 23 → Output 19, Input 28 → Output 23 (with a red X over the arrow), and Input 28 → Output 28. Below the queue are three icons: a left arrow, a zoom out icon, and a zoom in icon.

Simply tap the crosspoints you wish to connect (crosspoint will turn green) or disconnect (crosspoint will turn red) and watch as each command populates the Command Queue. Note that outputs that are already connected to a different input will show a red X indicating that the Auto-Interlock feature will disconnect that crosspoint and connect the new crosspoint (see output 19 in the example above).

When ready, press the  icon to apply the changes on the system. Or, to undo a selected command from the queue, simply tap the crosspoint again.

3.3.3. Crosspoint Navigator

The crosspoint navigator is a read only method of visualizing the current crosspoint status. From the Overview screen, tap the  icon to zoom-in.

From this screen, you may touch and drag the view to other sections of the matrix. From this screen, you can access the editor, zoom-out to the overview screen or enter the list view.

Note that inputs with active signal detection will indicate a + sign next to the input and also in the crosspoint connected indicator.

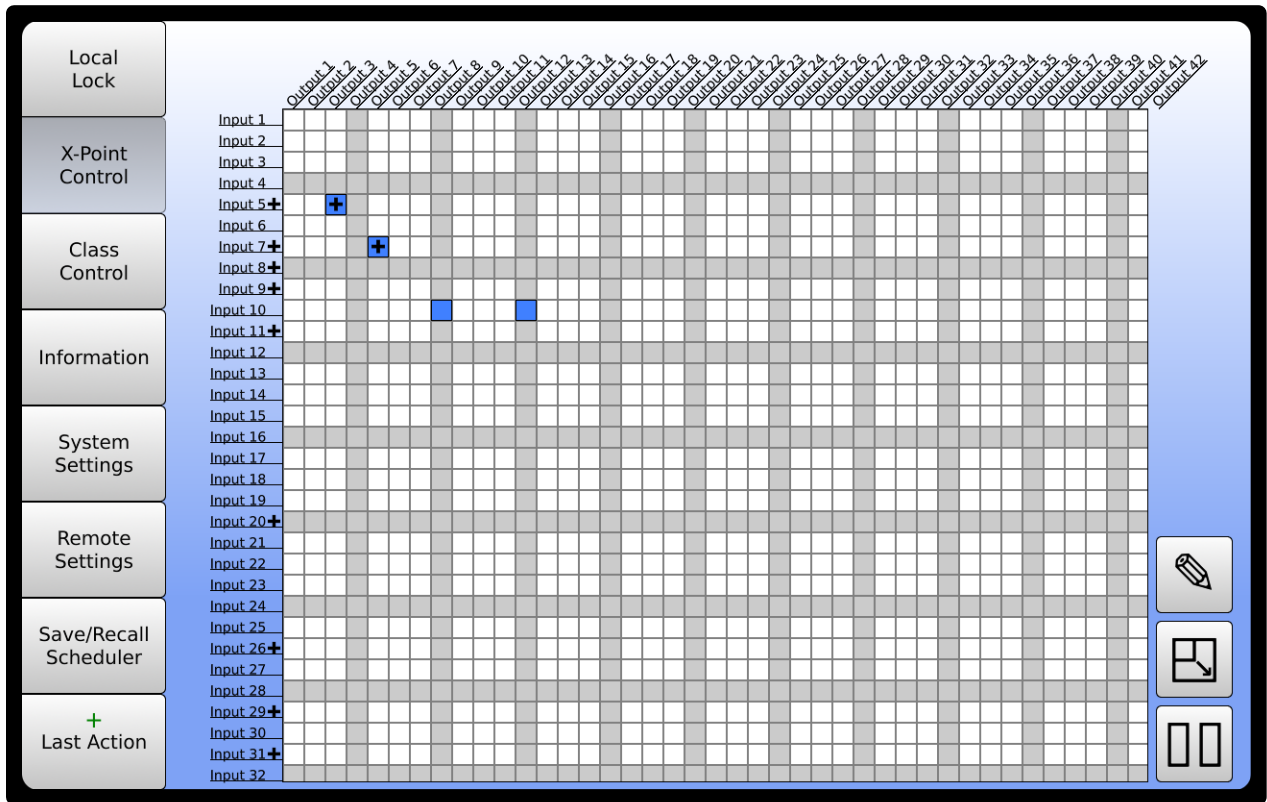

3.3.3.1. Active Signal Detection Verification

In the model S2560F / S2560FX, the system is constantly verifying signal present on inputs and outputs. If a crosspoint is connected, signal detection confirms that the signal is present on both the input and the output. Failure for a signal to appear on an output of a desired crosspoint or, the presence of a signal on a disconnected output is indicative of a system problem and fault code 99 will be generated. See Section 7 for more fault code definitions.

3.3.4. List View

The list view may be accessed by pressing the  icon from any previous menu. List View allows you to connect, disconnect or verify a given crosspoint.

You can also change the default titles of inputs and outputs. Simply press and hold the title for three seconds then edit the name with the on-screen keyboard that appears. These names may also be changed remotely using the LOUt and LIN functions described in Sections 5.3.31 and 5.3.32

Note that there is a ten character maximum for custom labels and restricted characters are the quotation mark, comma, and semicolon.

To revert back to the Grid View, press the  icon. Inputs with active signal detection will indicate a + sign next to the input.

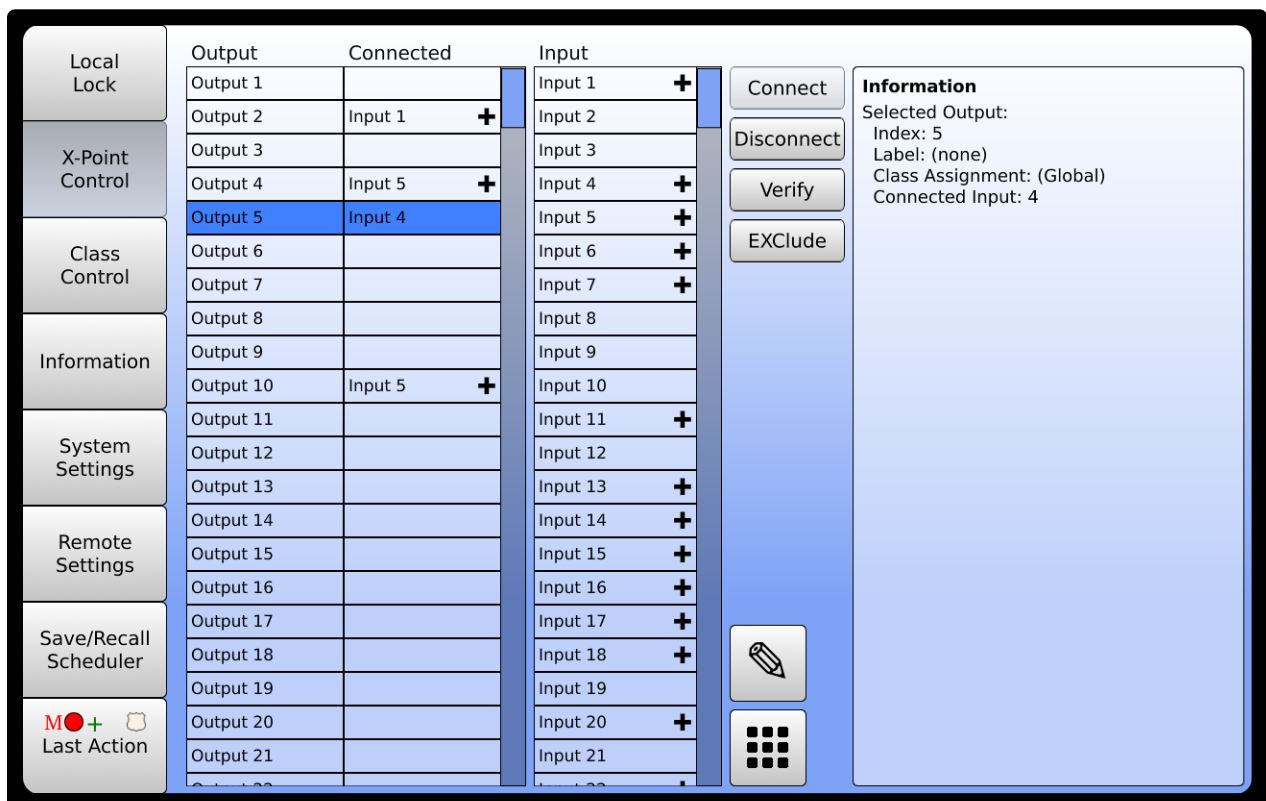



From the list view, you can connect, disconnect, verify a crosspoint, or add a crosspoint to the Exclude Table (See Section 3.6.1.5. for details).

3.3.5. List View Editor

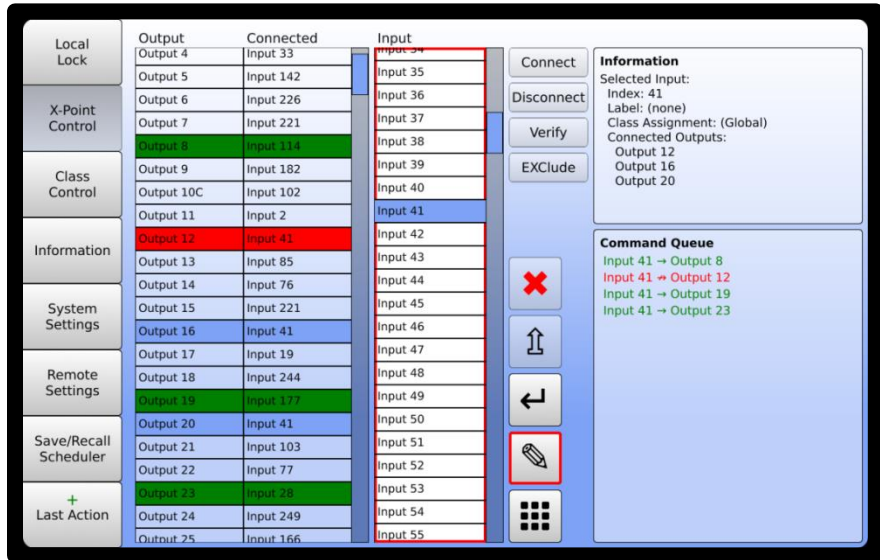
The list view may be accessed by pressing the  icon from the list view screen. You may now select crosspoint(s) for modification.



Note the shift icon  which allows you to select a range of outputs by tapping the bookends of the range. The command queue will populate and when finished, pressing the  key will execute all of the commands.

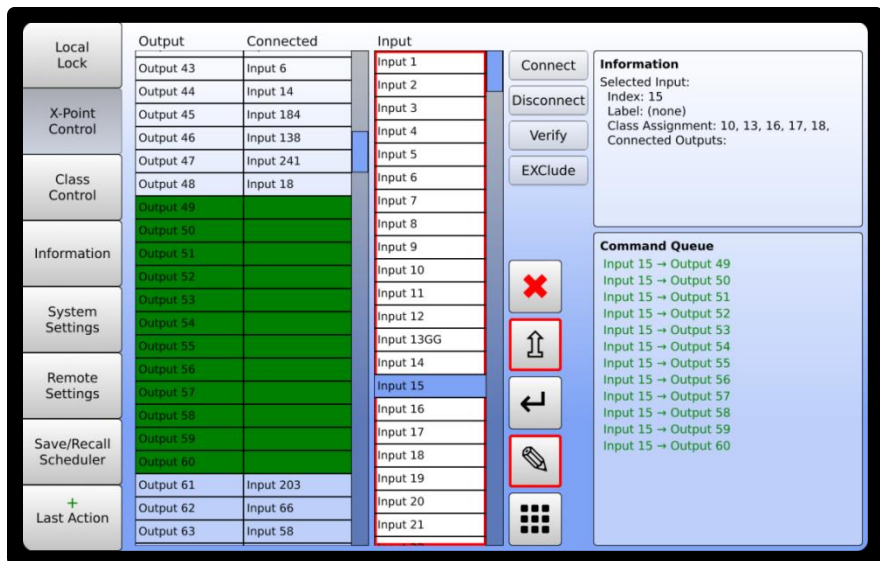

3.4. Class Control

Classing is a feature that allows the user to assign inputs and outputs to one or many classes where only similarly classed I/O's can be connected. This feature is useful for applications where only a specific set of inputs will only ever connect to a specific set of outputs and any deviations could have adverse results.

There are 32 available classes which are identified using their class index number: 1 – 32. By default, all I/O's are assigned class 0, or "Global" which allows for global access within the matrix.

3.4.1. Overview

The overview shown below lists the available I/O's on the left hand column with their designated class assignments listed at the top. You may toggle between inputs and outputs by view the assigned classes for the inputs by pressing the "Inputs" button in the upper right corner. By default, all I/O's are assigned to the global class. Use touch and drag to scroll up or down through the list of I/O's.

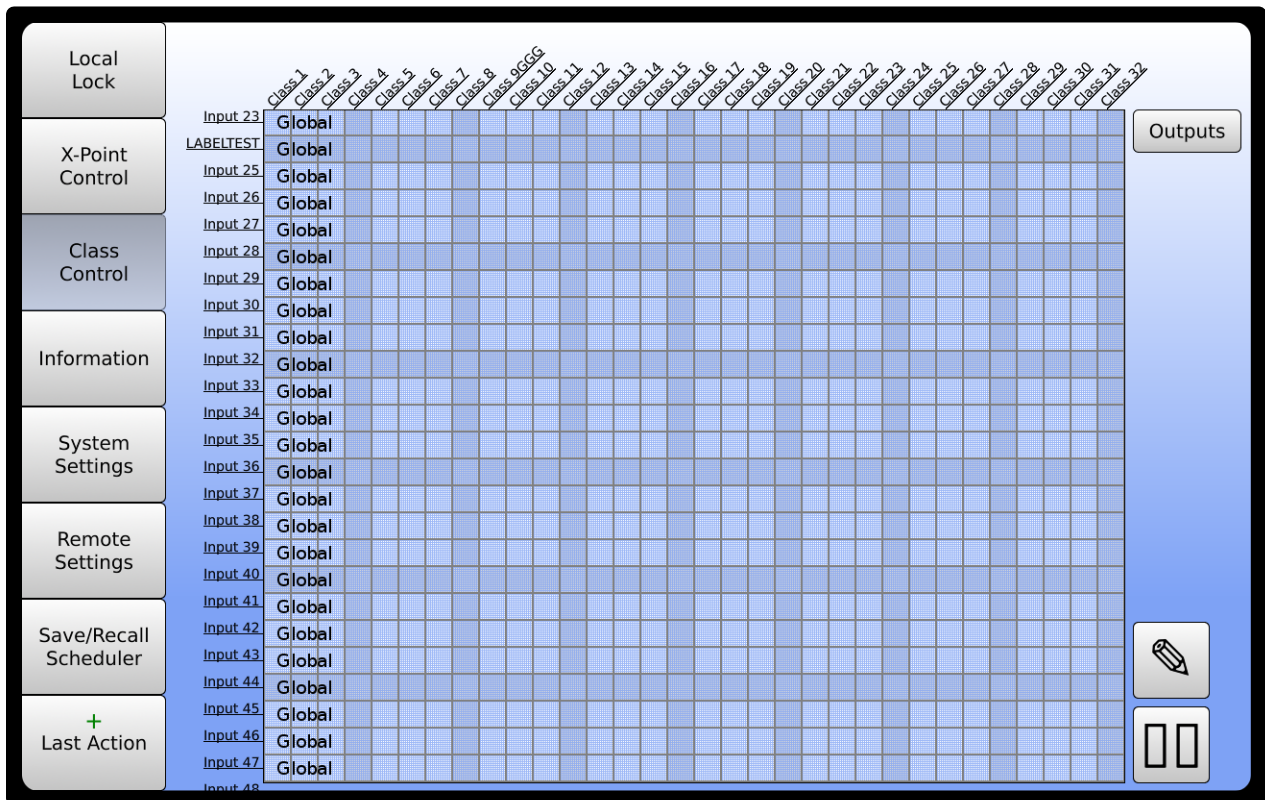

The screenshot displays a control interface for classing I/Os. On the left is a vertical menu with buttons: Local Lock, X-Point Control, Class Control, Information, System Settings, Remote Settings, Save/Recall Scheduler, and Last Action. The main area is a grid with 32 columns labeled Class 1 through Class 32, and rows labeled Input 23 through Input 48. The 'Global' class is assigned to all inputs. A 'LABELTEST' row is also present. On the right side, there are buttons for 'Outputs', a pencil icon, and a double rectangle icon.

	Class 1	Class 2	Class 3	Class 4	Class 5	Class 6	Class 7	Class 8	Class 9	Class 10	Class 11	Class 12	Class 13	Class 14	Class 15	Class 16	Class 17	Class 18	Class 19	Class 20	Class 21	Class 22	Class 23	Class 24	Class 25	Class 26	Class 27	Class 28	Class 29	Class 30	Class 31	Class 32
Input 23	Global																															
LABELTEST	Global																															
Input 25	Global																															
Input 26	Global																															
Input 27	Global																															
Input 28	Global																															
Input 29	Global																															
Input 30	Global																															
Input 31	Global																															
Input 32	Global																															
Input 33	Global																															
Input 34	Global																															
Input 35	Global																															
Input 36	Global																															
Input 37	Global																															
Input 38	Global																															
Input 39	Global																															
Input 40	Global																															
Input 41	Global																															
Input 42	Global																															
Input 43	Global																															
Input 44	Global																															
Input 45	Global																															
Input 46	Global																															
Input 47	Global																															
Input 48	Global																															

3.4.2. Class Editor

To assign a class or multiple classes to an input or output, press the  icon to access the editor. While in the editor, tap the class location for the corresponding I/O. You will see the location turn green and the Cmd Queue will populate with the class assignment. To undo or remove an assignment from the queue, tap the location again.



When complete, press the  icon. The Cmd Queue will be executed and you will return to the overview screen where you can see the new class assignments.



3.4.3. List View

The list view allows you to select any of the available classes, inputs or outputs to show their designated class assignments in the window. This can also be achieved remotely using the CLI? And CLO? Queries. See Section 5.4.1.4. for more details.

You can also change the default titles of classes. Simply press and hold the title for three seconds then edit the name with the on-screen keyboard that appears. These names may also be changed remotely using the CLL command described in Section 5.4.1.3. Inputs and outputs can be renamed using the tap and hold method on any of the class control screens.

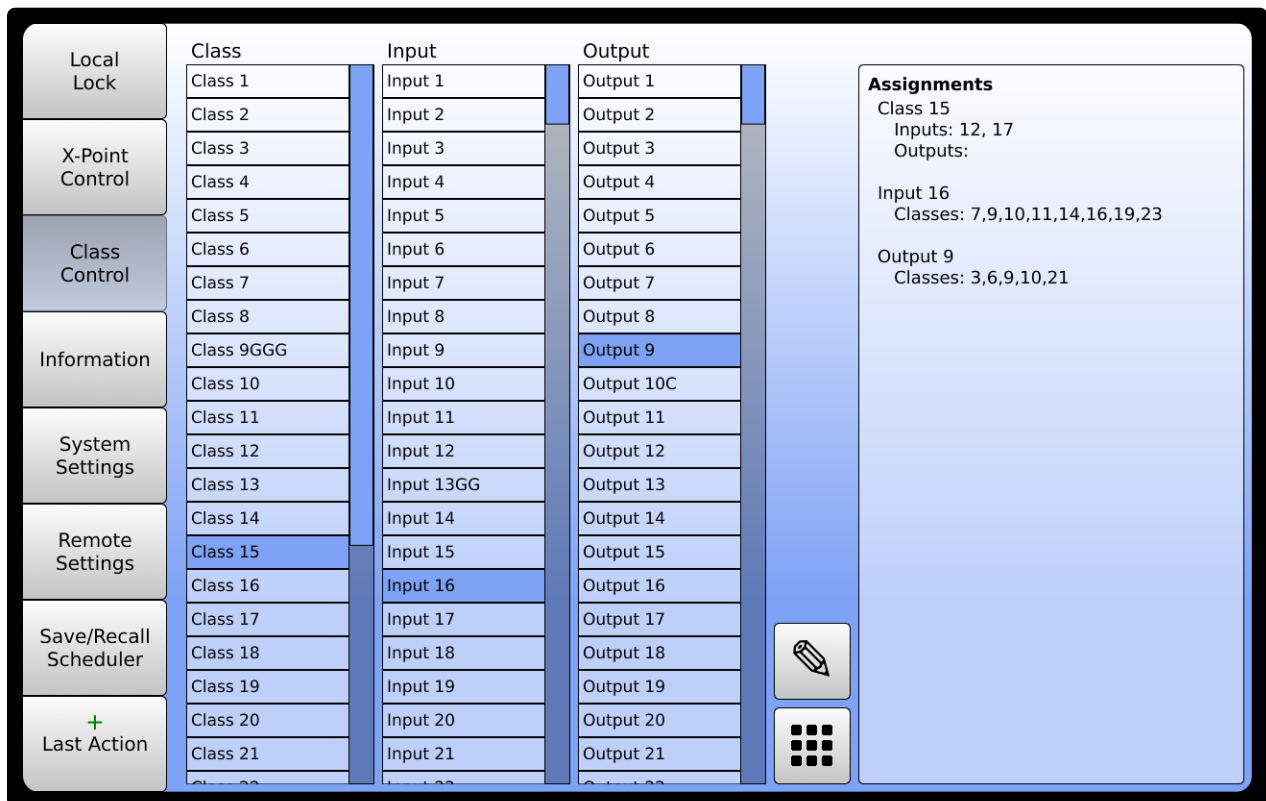

	Class	Input	Output
	Class 1	Input 1	Output 1
	Class 2	Input 2	Output 2
X-Point Control	Class 3	Input 3	Output 3
	Class 4	Input 4	Output 4
	Class 5	Input 5	Output 5
Class Control	Class 6	Input 6	Output 6
	Class 7	Input 7	Output 7
	Class 8	Input 8	Output 8
Information	Class 9GGG	Input 9	Output 9
	Class 10	Input 10	Output 10C
System Settings	Class 11	Input 11	Output 11
	Class 12	Input 12	Output 12
	Class 13	Input 13GG	Output 13
Remote Settings	Class 14	Input 14	Output 14
	Class 15	Input 15	Output 15
	Class 16	Input 16	Output 16
Save/Recall Scheduler	Class 17	Input 17	Output 17
	Class 18	Input 18	Output 18
	Class 19	Input 19	Output 19
+ Last Action	Class 20	Input 20	Output 20
	Class 21	Input 21	Output 21



Assignments

Class 15
Inputs: 12, 17
Outputs:

Input 16
Classes: 7,9,10,11,14,16,19,23

Output 9
Classes: 3,6,9,10,21

3.4.3.1. Editor

Access the editor by selecting the  icon. From within the editor, you may select a class to add an input(s) or output(s). Alternatively, you may select an input (or output) to assign a class(s). The assignments will populate in the command queue and will be executed once the  icon is pressed.

In the example below, we have selected input 7 for class assignment. The input column is highlighted in a red rectangle to indicate that it is active. To deactivate it, press input 7 again. Since an input is active, the outputs are greyed out and not available. Here we are adding classes 18, 14, and 6 to input 7 and removing class 7.

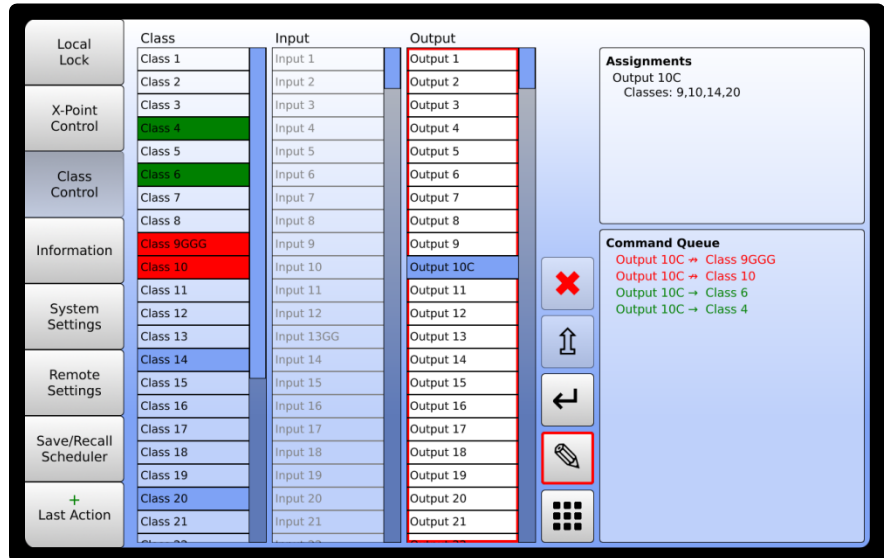

You may also use the  (shift) icon to select a range of classes, inputs and outputs to simplify the class assignment routine.

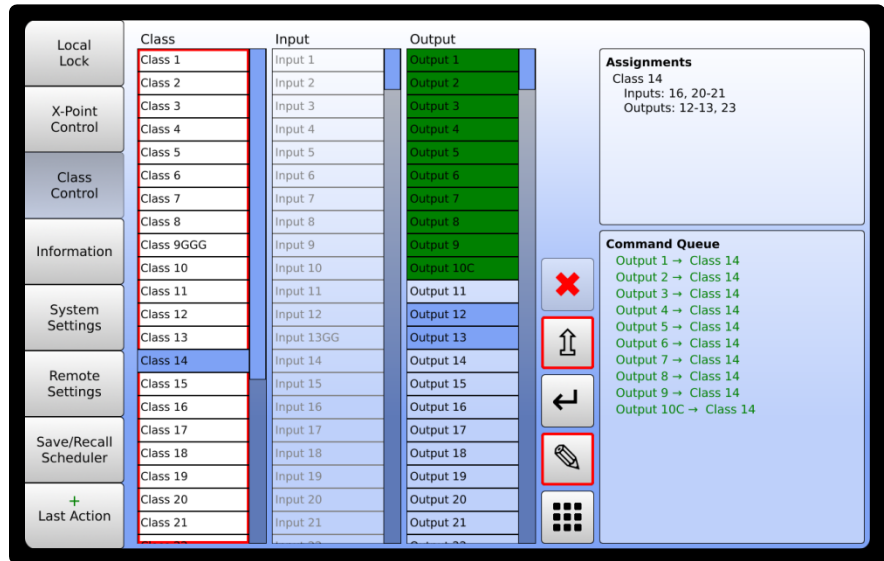

3.5. Information

The Information menu contains all relevant system information including firmware revision, power supply readings, module identification and the event log. Each item is summarized in this section.

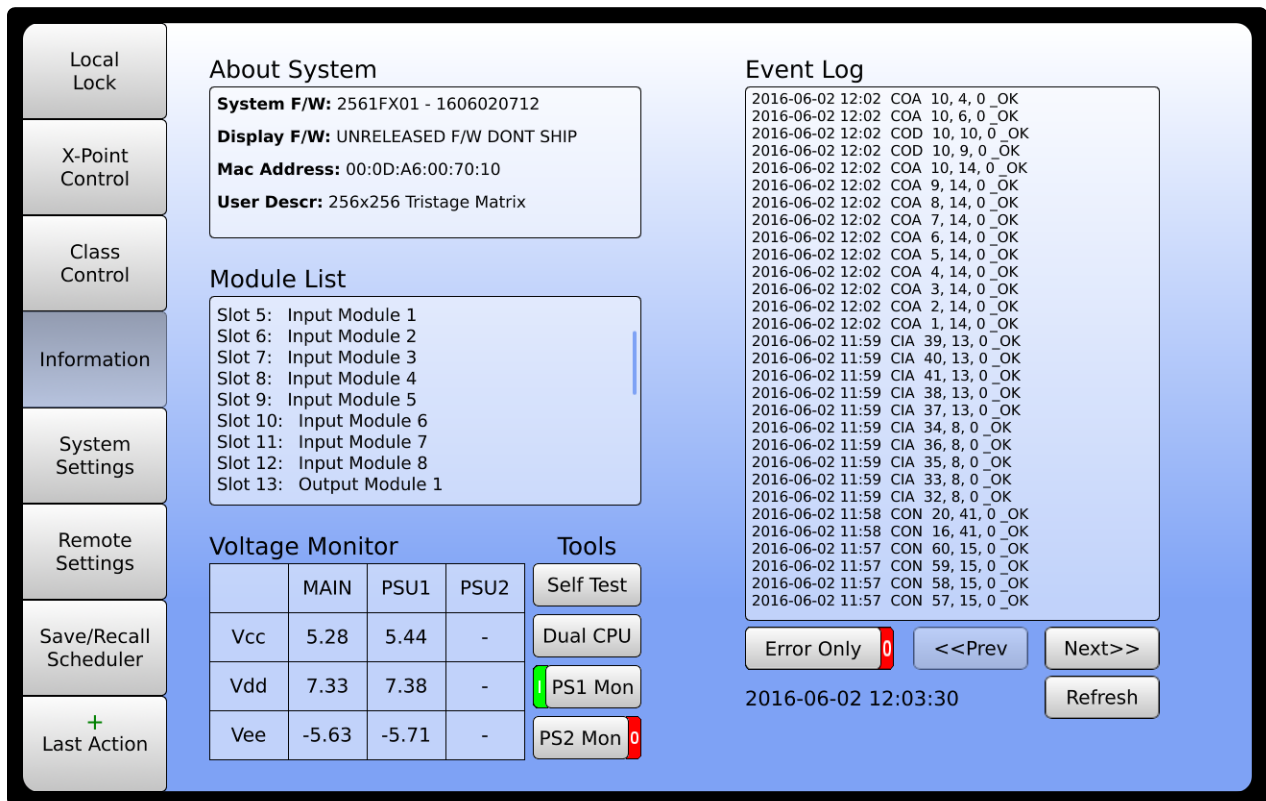

3.5.1. About System

The About System window includes information about the firmware, system MAC address and custom user description which may be changed from the web GUI.

System F/W:	System firmware model number – revision code
Display F/W:	Display firmware model number – revision code
MAC Address:	MAC address of the CPU
User Description:	User defined description of the system that can be changed from the web GUI. By default, it is the same as the System Description.

3.5.2. Voltage Monitor

The voltage monitor window shows the status of the power supply voltages in the system. It is divided into three columns including the Main, PSU1 and PSU2.

Main:	This is the voltage level as seen from the CPU processor (after the diode). It is a combination of voltages in redundant systems.
PSU1:	This is the voltage being read by the power supply monitoring board in Power Supply 1. (before the diode)
PSU2:	This is the voltage being read by the power supply monitoring board in Power Supply 2. (before the diode). Note that in single supply systems, these values will be zero.

The PS1 and PS2 buttons allow for turning the active power supply monitoring function on or off. This may be used in cases where a system programmed for redundant power supplies has only one power supply installed. By turning the monitoring off for the missing supply, you avoid receiving power supply missing faults and error indicators on the front panel.

Power Supply monitoring may be disabled by toggling the PS1 Mon button for power supply 1 or the PS2 Mon button for power supply 2.

3.5.3. Diagnostic

The diagnostic window shows the current module population. Empty, non-operational, or non-recognized modules are shown with a dash (-). Modules that the CPU expects to be installed but are not detected are designated with an "X". Expected and installed modules are shown in order from left to right with their accompanying slot number. In Tri-Stage™ products, slots 1-4 are reserved for the power supplies and are represented by the "?".

Note that slots 17-24 are reserved for mid-stage modules and should always be present for proper operation.

A self test button is available for when a module has been hot-swapped in or out of the system. This includes power supply and CPU in addition to switch modules. When pressed, the Main CPU will scan the system for all modules and will display the results.

The Dual CPU State button is for systems with dual redundant CPU's. In these systems, one of the CPU's acts as the master while the secondary is mirroring the master's contents. In some circumstances the user may need to know which CPU is acting as the master. Pressing this button will provide the following status options:

- Top Single** One CPU installed in slot CPU-1 – Master
- Top Dual** Dual CPU's installed, CPU-1 is the Master
- Bottom Single** One CPU installed in slot CPU-2 – Master
- Bottom Dual** Dual CPU's installed, CPU-2 is the Master

3.5.4. Event Log

The event log tracks all activity from any of the remote interfaces, web GUI, and front panel touchscreen display. Events are timestamped and show the command or query and results.

The Error Only button is a Boolean toggle that is either ON (green / 1) or OFF (red / 0). By toggling this function ON, you can filter out all events except for those that resulted in an error. There are also buttons available to refresh the log and scroll between multiple pages within the log.

The event log is also accessible from the Web GUI. Please see Section 5.3.35 and 9.7 for details.

3.6. System Settings

The System Settings menu contains all user-definable system settings and available actions including a factory reset, real time clock, display color and brightness. Each item is summarized in this section.

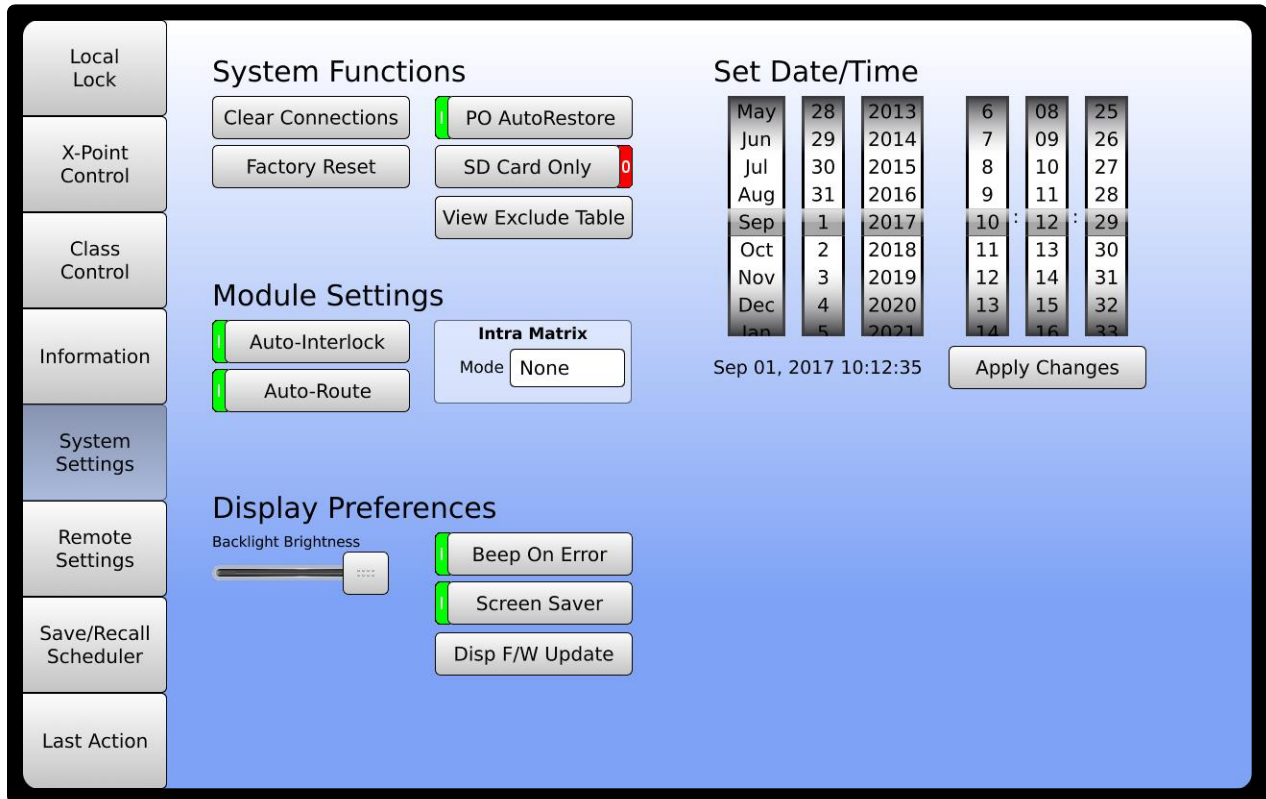

3.6.1. System Functions

The system functions window contains customizable settings pertaining to the system. The details of which are outlined below.

3.6.1.1. Clear Connections

This function will clear all of the crosspoints on the system. You will be prompted to confirm this action or cancel.

3.6.1.2. Factory Reset

You may use this button to restore the system to factory default settings. You will be prompted for the factory reset code: **7671**

After successfully entering the code and pressing Enter, you will be prompted to confirm the factory reset.

3.6.1.3. PO AutoRestore

Short for Power On Auto Restore, this parameter may be enabled (On) or disabled (Off). When enabled, the unit automatically restores the last configuration from before the unit was powered OFF (or power was lost to the unit). When disabled, all cross-points are automatically cleared on power ON. To change the setting, tap the Boolean toggle to the On or Off positions.

NOTE: The factory default is Power On AutoRestore enabled (On), so that the unit is returned to the last known cross-point state when powered ON.

3.6.1.4. SD Card Only

The system may optionally store configuration data and settings on an SD card, internal serial flash, or both. When the toggle is set to ON, the setting is in SD Card Only mode. When the toggle is set to OFF, the setting is in Redundant Mode. See Chapter 0 for more details.

The SD Card icon is shown in the top right corner of the display. The following table defines the color status:

Color	Definition
Black	Redundant mode with SD card present
Red	SD Only mode with SD card missing
Green	SD Only mode with SD card present

NOTE: The factory default is Redundant Mode(SD Card Only = Off). Lack of an SD Card icon on the display indicates that the system is in Redundant mode and an SD card is not present.

3.6.1.5. View Exclude Table

On Tri-Stage products, any given input to output may be processed through a number of mid-stages. If the signal performance is undesirable and a different mid-stage a preferred, the Exclude function can be used (See Section 3.3.4) to prevent the I/O from being routed through the mid-stage currently in use. Pressing the View Exclude Table Button will launch the Exclude Table

3.6.1.5.1.Exclude Table

Once accessed, you can undo an exclusion by pressing the Include button, clear all of the exclusions by pressing the Clear Exclude Table button, or perform the SCAN functions as detailed in Section 5.3.1.7.

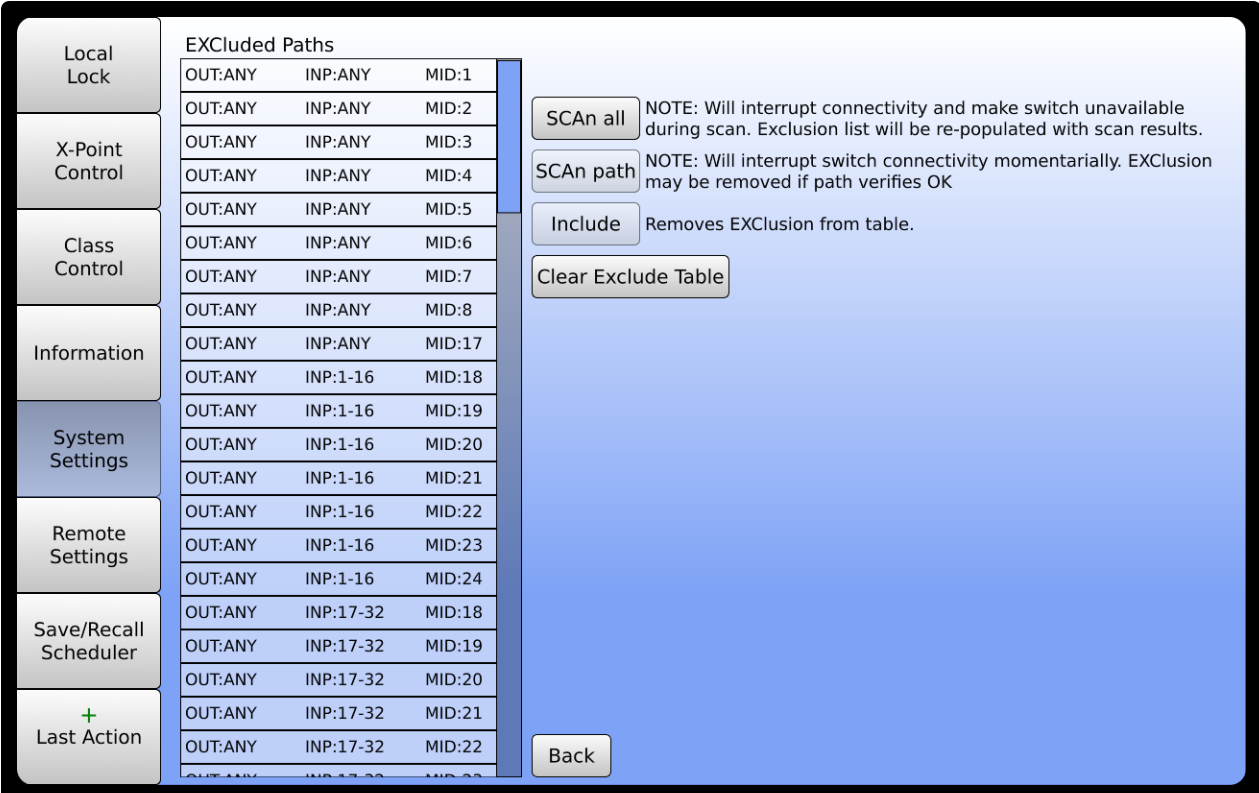

The screenshot displays the 'EXCLUDED Paths' interface. On the left is a vertical navigation menu with categories: Local Lock, X-Point Control, Class Control, Information, System Settings, Remote Settings, Save/Recall Scheduler, and Last Action. The main area contains a table with three columns: OUT, INP, and MID. Below the table are several control buttons: 'SCAN all' (with a note about interrupting connectivity), 'SCAN path' (with a note about momentary interruption), 'Include' (to remove exclusions), 'Clear Exclude Table', and 'Back'.

EXCLUDED Paths		
OUT:ANY	INP:ANY	MID:1
OUT:ANY	INP:ANY	MID:2
OUT:ANY	INP:ANY	MID:3
OUT:ANY	INP:ANY	MID:4
OUT:ANY	INP:ANY	MID:5
OUT:ANY	INP:ANY	MID:6
OUT:ANY	INP:ANY	MID:7
OUT:ANY	INP:ANY	MID:8
OUT:ANY	INP:ANY	MID:17
OUT:ANY	INP:1-16	MID:18
OUT:ANY	INP:1-16	MID:19
OUT:ANY	INP:1-16	MID:20
OUT:ANY	INP:1-16	MID:21
OUT:ANY	INP:1-16	MID:22
OUT:ANY	INP:1-16	MID:23
OUT:ANY	INP:1-16	MID:24
OUT:ANY	INP:17-32	MID:18
OUT:ANY	INP:17-32	MID:19
OUT:ANY	INP:17-32	MID:20
OUT:ANY	INP:17-32	MID:21
OUT:ANY	INP:17-32	MID:22
OUT:ANY	INP:17-32	MID:23
OUT:ANY	INP:17-32	MID:24

NOTE: Will interrupt connectivity and make switch unavailable during scan. Exclusion list will be re-populated with scan results.
 NOTE: Will interrupt switch connectivity momentarily. EXCLUSION may be removed if path verifies OK
 Removes EXCLUSION from table.

3.6.2. Module Settings

Module settings are those that apply to the switch matrix inputs and outputs. These optional settings are described below.

3.6.2.1. Auto-Interlock

Two (2) modes of "AUTO INTERLOCK" control are available. With the Auto-Interlocking feature enabled (On), the unit automatically disconnects any input connected to the specified output port before making the new input connection. This simplifies control and prevents the system from generating "output already in use" errors.

With the input Auto-Interlocking feature disabled (Off), the user must send a disconnect command for the desired output (if currently in use) prior to connecting any new input.

To change the setting, tap the Boolean toggle to the On or Off positions.

NOTE: The factory default is Auto-Interlock mode enabled (On).

3.6.2.2. Auto-Route Mode

The AUTO-ROUTE mode routes the connection command without the need to address a specific module number. Tri-Stage™ or Output End-to-End systems are configured in AUTO-ROUTE mode.

3.6.2.3. Intra Matrix

C3 compatible systems are capable of internally ganging input and output pairs for synchronous clock/data applications within a single switch matrix. This feature allows for a single command (via front panel or remote interface) to control two crosspoints simultaneously. There are two different approaches for internally ganging input and output pairs:

- **Series Ganging**

In this mode, the software "Input 1" translates to the hardware inputs 1 and 2. "Input 2" translates to inputs 3 and 4. This pattern continues for the full size of the matrix. This operational mode is ideal to maintain maximum propagation delay matching between clock and data pairs.

- **Parallel Ganging**

In this mode, the matrix is divided in two where a normal 32x32 matrix now becomes two sections of 16x16. The software "Input 1"

translates to the hardware inputs 1 and 17. “Input 2” translates to inputs 2 and 18. This pattern continues for the full size of the matrix. This operational mode provides an additional option for the end user and may be preferred to the series ganging approach depending on the users installation and application use.

You may also enable the settings on the Switch State page in the web GUI. See Section 9.5 for more details.

3.6.3. Display Preferences

In the Display Preferences window, you may adjust the backlight brightness. The screen saver function will dim the display after 5 minutes of no activity. The default state for this function is ON. To turn it off, tap the Boolean toggle switch to OFF.

3.6.3.1. Beep On Error

The unit has an internal beeper to indicate an error. This assists the user during firmware development and alerts the user of equipment failure. The unit also has a RED front panel indicator labeled that illuminates during an error condition.

NOTE: The factory default is Beep On Error enabled (On).

To change the setting, tap the Boolean toggle to the On or Off positions.

3.6.4. Set Date/Time

Use the scroll wheels to set the current date and time for the real time clock functions. When complete, press the Apply Changes button. Additionally, the system can be set to synchronize with an NTP server via the web interface. See Section 9.3 for details.

3.7. Remote Settings

The system CPU processor(s) have multiple settings that can be changed by the user. This menu does not vary between the various sized touchscreen displays and as such, please refer to Section 2.14.5 for details.

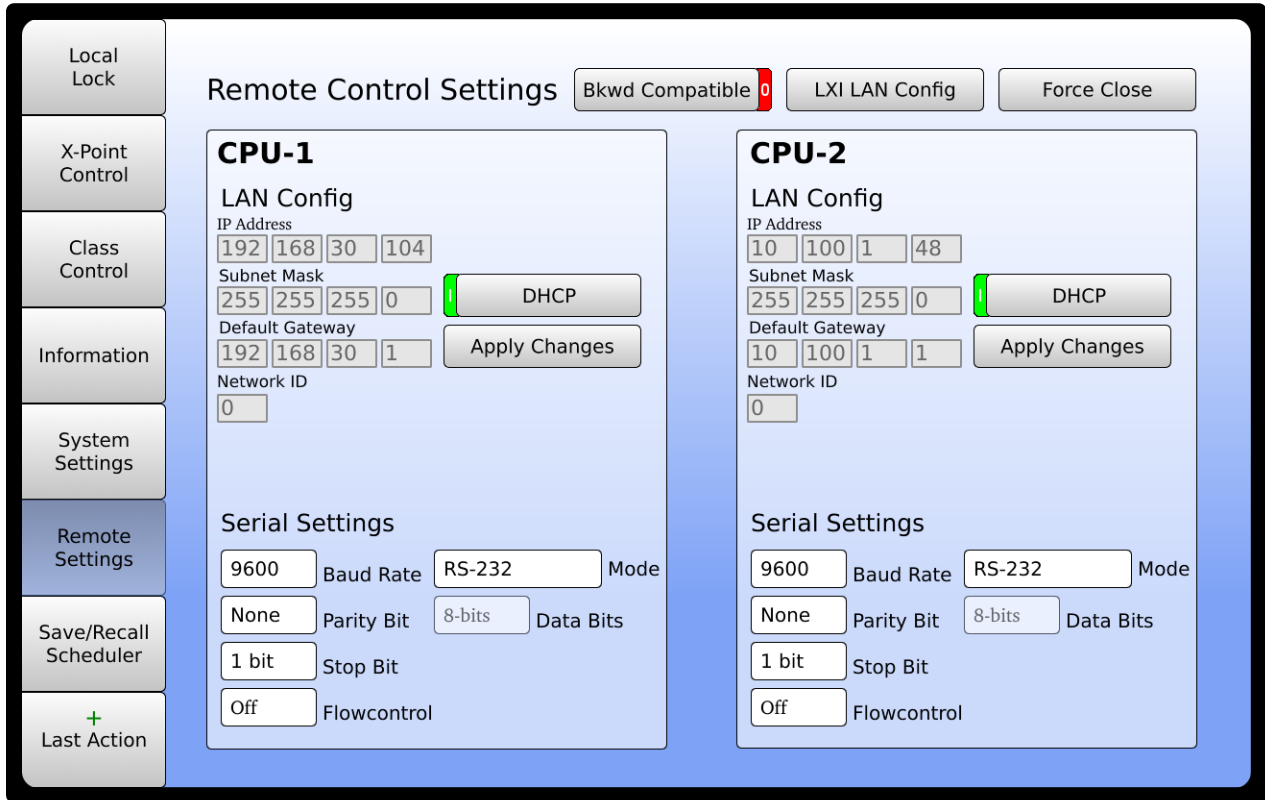

3.8. Save / Recall Scheduler

The System can save and recall different crosspoint configurations from the CPU's memory. When a configuration is saved, the entire switching array configuration is saved into the storage memory location chosen by the user. The configuration is also time stamped for identification purposes.



The screenshot shows a software interface with a sidebar on the left containing menu items: Local Lock, X-Point Control, Class Control, Information, System Settings, Remote Settings, Save/Recall Scheduler, and Last Action. The main area is divided into two sections: 'Save/Recall Table' and 'Event Scheduler'.

Save/Recall Table:

	Name	Last Saved
1		
2		
3		
4		
5	QWED	2016-06-02 12:06
6		
7	MISSION1	2016-06-02 09:09
8		
9		2016-06-02 07:00
10		
11	RRRTTTTTT	
12	ZXCV	2016-06-02 09:29
13		
14		
15		
16		

Buttons: Save, Recall

Event Scheduler:

Time	Scheduled Event	Repeat
0:00		ON/OFF
0:30		ON/OFF
1:00		ON/OFF
1:30	Recall QWED	ON/OFF
2:00		ON/OFF
2:30		ON/OFF
3:00		ON/OFF
3:30	Recall Memory 9	ON/OFF
4:00		ON/OFF
4:30		ON/OFF
5:00		ON/OFF
5:30		ON/OFF
6:00		ON/OFF
6:30		ON/OFF
7:00		ON/OFF
7:30		ON/OFF

Buttons: Add, Delete, Repeat, Discon All

*Highlight desired save location on save/recall table to add event

To save or recall a configuration, use the scroll bar on the right hand side to locate the desired numerical memory location. Touch the line item to highlight it, then select the save button to save the configuration or the recall button to recall a saved configuration. In either case, a confirmation window will appear prompting the user to confirm the action.

3.8.1. Configuration Labels

You may also rename a configuration to something a bit more application specific. To add a label to a saved configuration, simply press and hold the name for three seconds then edit the name with the on-screen keyboard that appears. These names may also be changed or queried remotely using the STL / STL? Function described in Sections 5.3.33 and 5.3.34 (Also see Sections 9.5 and 9.6 for web GUI access).

Note that there is a ten character maximum for custom labels and restricted characters are the quotation mark, comma, and semicolon.

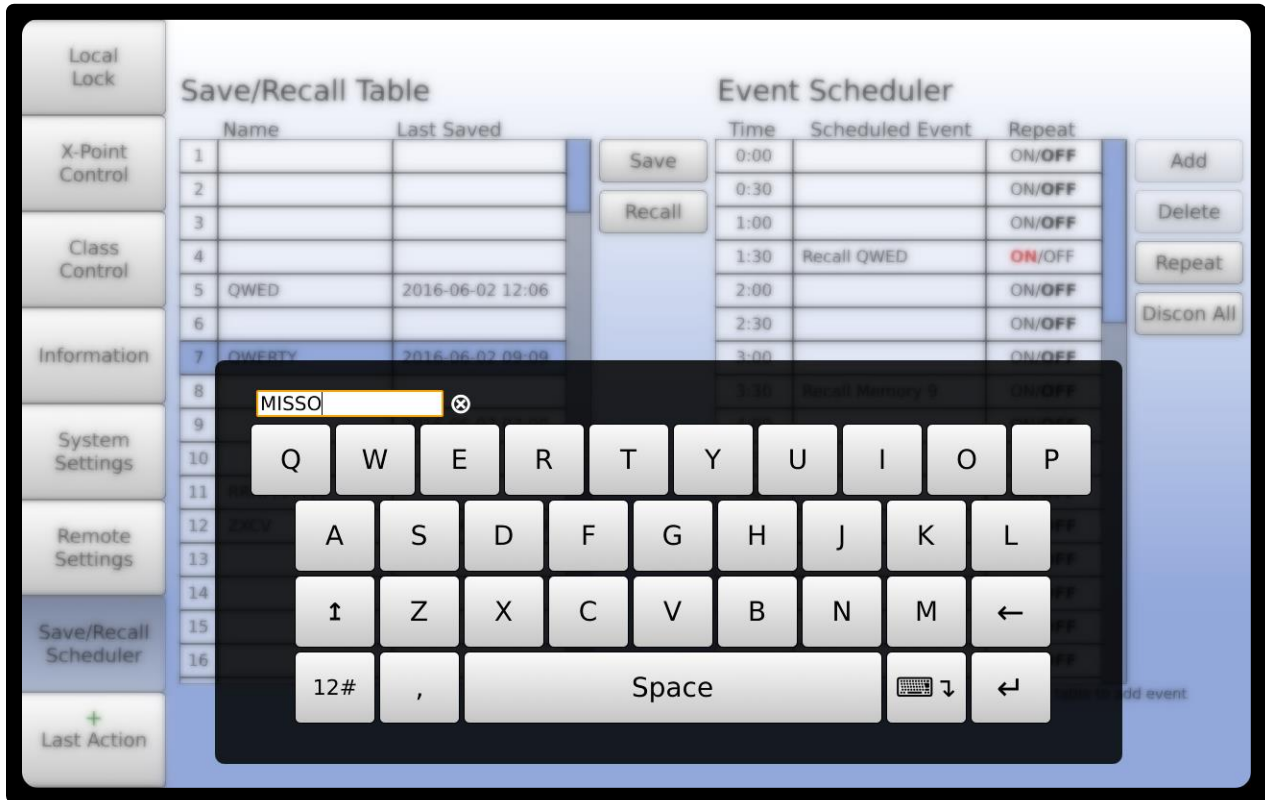

3.8.2. Event Scheduler

The Event Scheduler allows the operator to schedule a recall of a pre-saved crosspoint configuration index number. Events can be scheduled every 30 minutes over a 24 hour period. Events can be flagged to repeat every day or not.

To add a new event to the scheduler, highlight the desired event from the Save/Recall Table then highlight the desired time slot on the Event Scheduler table and press "Add". You can also toggle the ON/OFF to repeat the event every 24 hours if required.

You may also use the "Discon All" button schedule an event that disconnects all crosspoints. Simply highlight the desired time slot on the Event Scheduler table and press the "Discon All" button.

3.9. Last Action

The Last Action button will display the most recent command received either from the front panel or remote interfaces. If the system is in an active session with RouteWarePRO (See Section 12.1 for details), the RouteWarePRO shield will be flashing.

If the system is in a Master / Remote configuration, a red capital letter M will be shown to indicate it is the Master.

When a command is sent to the system via the front panel or any remote interface that changes the status of the system in any way, the new status is written to serial flash. To indicate that a change is being made to the flash memory, a red LED type indicator is shown in the Last Action button.

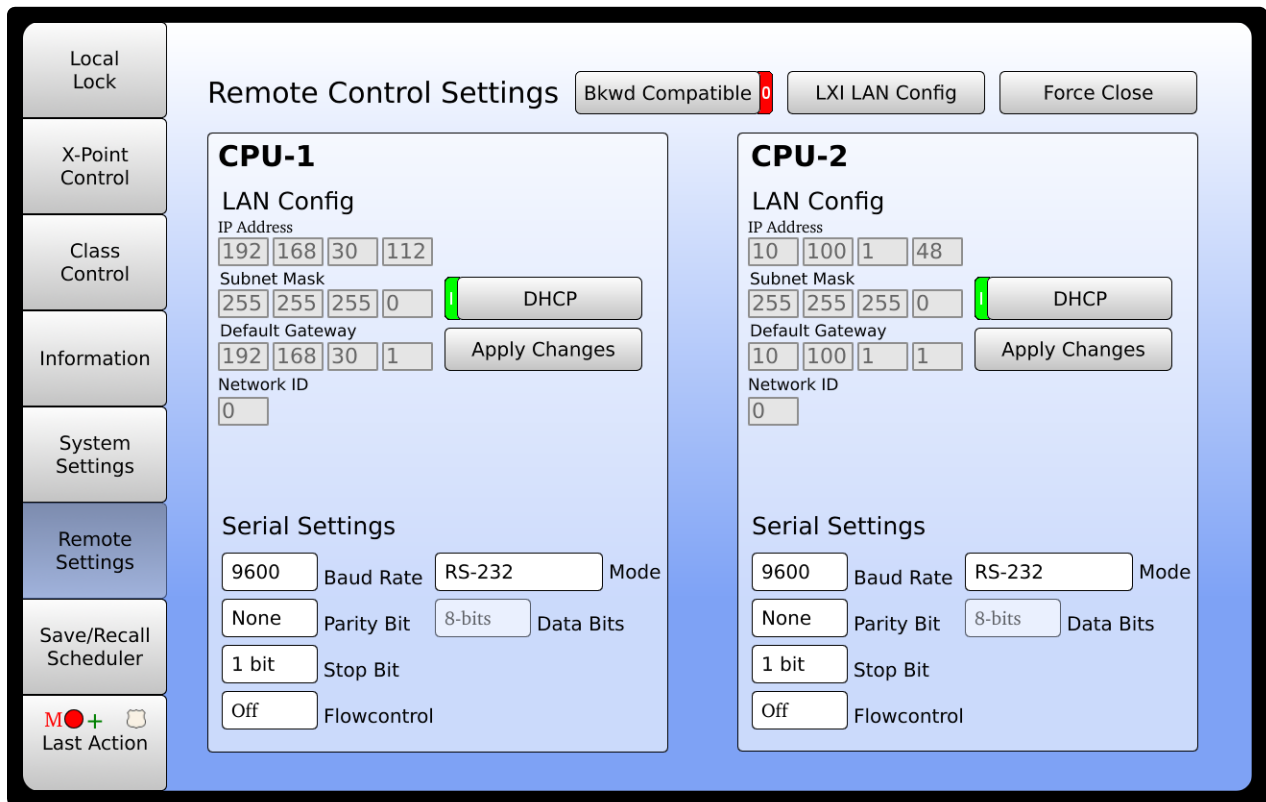

The screenshot displays the 'Remote Control Settings' interface. On the left is a vertical navigation menu with buttons for: Local Lock, X-Point Control, Class Control, Information, System Settings, Remote Settings, Save/Recall Scheduler, and Last Action (which has a red 'M' icon and a plus sign). The main area is titled 'Remote Control Settings' and contains several control elements: 'Bkwd Compatible' (with a red '0' indicator), 'LXI LAN Config', and 'Force Close' buttons. Below this are two columns for 'CPU-1' and 'CPU-2'. Each column has a 'LAN Config' section with input fields for IP Address, Subnet Mask, and Default Gateway, a 'DHCP' button, and an 'Apply Changes' button. Below the LAN config is a 'Serial Settings' section with dropdown menus for Baud Rate (9600), Mode (RS-232), Parity Bit (None), Data Bits (8-bits), Stop Bit (1 bit), and Flowcontrol (Off).

**THIS PAGE WAS
INTENTIONALLY LEFT
BLANK**

4. Communicating with the System

This system offers flexibility for remote control by offering a variety of interfaces. Remote control over may be established over any or all of the interfaces simultaneously. These interfaces include:

- **TCP/IP (Ethernet).**

The embedded CPU supports 10/100 Base-T Ethernet networks, is LXI and SNMP compliant. See Section 8.1.1 for more details

- **RS-232C/422A/485.**

Also known as serial interface were originally developed for modems and data terminals. These types of interfaces are now commonly used for controlling a wide range of hardware configurations. See Section 8.1.2 for more details.

- **USB**

USB 2.0 (Type-A) for serial control. See Section 8.1.2.2. for more details.

All interfaces comply with a derivative of the IEEE 488.2 protocol. These interfaces allow computers to access the system's operating features providing remote access to configure, control and receive operating status of the switching system.

4.1. Remote Resources

The most versatile way to communicate is through Virtual Instrument System Architecture (VISA) library. Typically, this API contains a series of functions designed for interface-independent, device-independent and platform-independent access to instruments connected to a "host". To use, the calling program calls the function `viOpen()` with a "resource name" as one of the arguments. If successful, the function returns a handle to a VISA "session" which can be used to call the other VISA functions.

A download of VISA usually contains an application for accessing the API from either a command line or a GUI. This can also be used to access the instrument. Don't forget to append the "linefeed" character (`'\n'` or `0x0a`) as the last character.

The VISA API requires the resource descriptor to figure out how to communicate with the instrument. Some tasks of the VISA API are explained below:

- It figures out which calls to make to which interface (socket, GPIB, serial or future interfaces)
- It knows the capabilities of each interface. For example, the viReadSTB function “serial polls” a GPIB instrument, but send “*STB?\n” and read the response on serial or TCP/IP. It knows that serial has a baud rate and that GPIB has, among other lines, attention and trigger.
- Buffers characters, manages time-out.
- Multiple sessions can be opened to each instrument. It automatically handles contention issues (including locks).

4.1.1. Example Resource Descriptors

Examples of resource descriptors are:

- **GPIB0::20::INSTR**
The instrument at address 20 on GPIB interface card 0.
- **ASRL1::INSTR**
The instrument connected to serial port 1.
- **TCPIP::10.100.1.49::7145::SOCKET**
The instrument at the indicated IP addresses listening in on port 7145.

4.1.2. GUI and Commands Line Level of Control

At the GUI and command line levels, there are several ways to control the instrument. One of the most popular is HyperTerminal from Hilgraeve. (typically embedded in Windows XP). It works with serial as long as the user appends the linefeeds.

Most operating systems include some form of Telnet. It also works as long as the user changes the port from Telnet’s default 23 to one of the CPU’s available ports. See Section 8.1.1.1. for more information on available ports.

5. Remote Control Commands

The system can be controlled through any of the remote interfaces available on the CPU controller. The control commands are the same regardless of the interface in use.

Universal Switching products utilize a 488.2 compliant control protocol. For support of older US2, US3 US4, and MSC control protocols, contact Customer Support.

5.1. Changing Between Control Protocols

The 488.2 protocols are the factory default and are enabled when a system is delivered from the factory unless specifically requested by the end user for an alternative default mode. Additional control modes such as USx, Matrix Systems, etc. may be available. These modes are considered to be "Backwards Compatibility Mode".

The user may change the control mode, but it is recommended that any software developed for new applications utilize 488.2 compliant protocols. See Section 2.14.5.4. on how to change the mode from the front panel.

If the system is in 488.2 mode, you may send the remote command SET 29,0 to set the system to backwards compatibility mode. However, once in the backwards compatibility mode, there is no remote command that will set the system back to 488.2 mode.

5.2. Syntax Conventions

The following outlines the proper syntax of the commands for the 488.2 protocol:

- Words in the format XXXxxxx represent keywords. The upper case part is required; the lower case part is optional. Any combination of upper and lower case characters is acceptable (example: CONnect – the CON is required and minimally acceptable).
- Italicized words represent values (example: *output*)
- () represents optional words or combinations, | means that a choice can be made among the possibilities.
- Numbers must be whole numbers in base 10. Leading zeros are ignored. As a departure from the 488.2 protocol, decimal numbers, scientific notation and arithmetic expressions are not accepted.
- Where spaces are shown, at least one space must appear unless there's a comma. An arbitrary number of spaces can be used in addition to the required one.
- A "compound" command may be formed by placing a ; between commands.
- A command must be terminated with the ASCII linefeed character (0x0a, 10, or Ctrl-J).
- Responses are sent only in reply to queries (commands which end with "?").

The switching mode for the system may be enabled in AUTO-ROUTE or GANGED mode. AUTO-ROUTE mode does not need the "MODule" parameter in the command syntax for the following commands:

- **CONnect**
- **DISconnect**
- **QUERy**

NOTE: For additional information about the functionality of MODES, please refer to the CONTROL INFORMATION in Section 6.2.

5.3. IEEE 488.2 Compliant Command Set

5.3.1. System Specific Commands – Tri-Stage™

The architecture of Tri-Stage™ systems allow for specific commands applicable to the S256x series of products. The operand range of the following commands must be from 1 to the highest acceptable value for the system.

5.3.1.1. EXClude Command

This command is used to exclude a particular signal path or an entire mid-stage. The crosspoints are added to the exclusion list. EXClude (Output) *output*, (Input) *input*, (Midstage) *midstage*

Example:

```
EXC 1, 2, 3           Excludes OUT:1, IN:2, MID:3
EXC ALL, ALL, 1      Excludes all crosspoints on MID:1
```

5.3.1.2. EXL? Query

This query is used to read the contents of the exclusion list. The response is in JSON format.

```
{"pathExcluded": [{"o":<output>, "i":<input>, "m":<midstage>}]}
```

Example:

The example response below indicates that OUT 5, IN 3, MID 2 and OUT 10, IN 5, MID 20 are included in the exclusion list.

```
EXL?
{"pathExcluded": [{"o":5, "i":3, "m":2}, {"o":10, "i":5, "m":20}]}
```

5.3.1.3. INClude Command

This command is used to undo a signal path exclusion. INClude (Output) *output*, (Input) *input*, (Midstage) *midstage*

Example:

```
INC 1, 2, 3           Includes OUT:1, IN:2, MID:3
```

5.3.1.4. XCL Command

This command clears all signal path exclusions. The exclusion list allows for 100 entries.

```
XCL
```

5.3.1.5. ISP? Query

NOTE: Only available in the series S2560F / S2560FX system.

The ISP? Query (Input Signal Present) can be used to determine if an external signal is detected on a specified input or any input. The command is structured:

Input	Equation = $2^{(index - 1)}$	Decimal Value
1	2^0	1
2	2^1	2
3	2^2	4
4	2^3	8
5	2^4	16
6	2^5	32
7	2^6	64
8	2^7	128
9	2^8	256
10	2^9	512
11	2^{10}	1024
12	2^{11}	2048
13	2^{12}	4096
14	2^{13}	8192
15	2^{14}	16384
16	2^{15}	32768
17	2^{16}	65536
18	2^{17}	131072
19	2^{18}	262144
20	2^{19}	524288
21	2^{20}	1048576
22	2^{21}	2097152
23	2^{22}	4194304
24	2^{23}	8388608
25	2^{24}	16777216
26	2^{25}	33554432
27	2^{26}	67108864
28	2^{27}	134217728
29	2^{28}	268435456
30	2^{29}	536870912
31	2^{30}	1073741824
32	2^{31}	2147483648

Table 5-1: Input Decimal Value

ISP? ALL | *input*

Responses to individual input queries will be binary with a 1 indicating that signal is present and a 0 indicating that signal is not present.

ISP? 5 Checks if there is signal detected at input 5. Will respond with 1 or 0.

Responses to all inputs being queried begin with the number of input assemblies that are installed followed by bit-weighted values where each input assembly is assigned a decimal value using the formula $2^{(index-1)}$. Table 5-1 to the left illustrates the decimal value for each input on a given input assembly. Note that each assembly has 32 inputs.

In cases where an input assembly has signal present on multiple inputs, the decimal value of each input will be added to each other. A simple decimal to binary conversion will identify the inputs with signal present.

For example, assume a fully populated system with eight input assemblies has signal present on inputs 9, 17 and 26 only.

ISP? ALL would return;
8, 33620224, 0, 0, 0, 0, 0, 0, 0

The response is interpreted as having "8" input assemblies installed, each with 32 inputs. The first input assembly shows signal present on some inputs that total a decimal value of "33620224". Converted to binary, the response shows high values for bit positions 9, 17, and 26:

0010 0000 0001 0000 0001 0000 0000

Since this value is in position one of the response, we know that it directly correlates to logical inputs 9, 17, and 26. The remainder of the response shows that input assemblies 2-8 (0, 0, 0, 0, 0, 0, 0) do not have any signal present.

In another example, assume a partially populated system with only four input modules has signal present on inputs 25, 26, 39, 40, 63, 64, 110, and 112. Using Table 5-2 to the left, we know that:

Inputs	Input Assembly
1-32	1
33-64	2
65-96	3
97-128	4
129-160	5
161-192	6
193-224	7
225-256	8

- inputs 25 and 26 are on input assembly 1
- inputs 39, 40, 63 and 64 are on input assembly 2
- inputs 110 and 112 are on input assembly 4

Example:

ISP? ALL would return;

Table 5-2: Input Assembly Reference

4, 50331648, 3221225664, 0, 40960

The response is interpreted as having “4” input assemblies installed, each with 32 inputs. The first input assembly shows signal present on some inputs that total a decimal value of “50331648”. Converted to binary shows high values for bit positions 25 and 26:

11 0000 0000 0000 0000 0000

Since this value is in position one of the response, we know that it directly correlates to logical inputs 25 and 26.

Input assembly number two has signal present on inputs that total a decimal value of “3221225664”. Converted to binary shows high values for bit positions 7, 8, 31, and 32.

1100 0000 0000 0000 0000 0000 1100 0000

Since this value is in position two of the response, we have to add 32 to each value to determine it’s logical input value:

- 7 + 32 = 39
- 8 + 32 = 40
- 31 + 32 = 63
- 32 + 32 = 64

There is no signal present on input assembly number three.

Input assembly number four has signal present on inputs that total a decimal value of “40960”. Converted to binary shows high values for bit positions 14 and 16.

1010 0000 0000 0000

Since this value is in position four of the response, we have to add 96 to each value to determine it's logical input value:

$$14 + 96 = 110$$

$$16 + 96 = 112$$

5.3.1.6. OSP? Query

NOTE: Only available in the series S2560F / S2560FX system.

The OSP? Query (Output Signal Present) can be used to determine if signal is being passed to the output stage of the system. This can be useful in troubleshooting a system where signal is expected on an output device but is not detected. The user may specify a specific output or check all of the outputs with a single command. The command is structured:

```
OSP? ALL | output
```

The response is in the same format as the ISP? Query. Please refer to Section 5.3.1.5. for details and examples.

5.3.1.7. SCAN? Query

NOTE: Only available in the series S2560F / S2560FX system.

Note: The SCAN? Query is disruptive to existing crosspoints. Its use is only recommended during mission down-time or troubleshooting.

The SCAN? Query is a powerful self test mechanism whereby the system will generate its own signal and scan crosspoints for connectivity. The test requires that the existing crosspoints are disconnected in order to complete. Upon completion, pre-existing crosspoints will be recalled. The time duration to complete the test is dependent upon the system configuration. In general, the user should allow 5 minutes to complete a full system scan. The user may specify a particular crosspoint or all of the crosspoints with a single command. The command is structured:

```
SCA? ALL | output,input,midstage
```

The response will be in JSON notation which shows only the crosspoints that have failed the test. A zero response indicates a successful test. Failed crosspoints will automatically be added to the exclusion list (See Section 5.3.1.1. for details). Note that when scanning a specific crosspoint, including the midstage is optional. If it is not included, a random midstage will be selected and tested.

Examples:

1. All crosspoints passed the test with the exception of OUT 5, IN 3, MID 2 and OUT 10, IN 5, MID 20.

```
SCA? ALL
{"pathExcluded":[{"o":5,"i":3,"m":2},{ "o":10,"i":5
,"m":20}]}
```

2. All crosspoints passed the test:

```
SCA? ALL
0
```

3. OUT 45, IN 17, MID 30 passed the self-test:

```
SCA? 45,17,30
0
```

4. OUT 12, IN 1 passed the self-test through a randomly selected midstage.

```
SCA? 12,1
0
```

5. OUT 22, IN 19 failed on midstage 13 and the crosspoint was added to the exclusion list :

```
SCA? 22,19
{"pathExcluded":[{"o":22,"i":19,"m":<13>}]}
```

5.3.1.8. CVE? Query

NOTE: Only available in the series S2560F / S2560FX system.

Note: The CVE? Query is not disruptive to existing crosspoints.

The CVE? query (Connect Verify) is a powerful command used to connect crosspoints and provide the user with operational feedback including self-testing results. For every CVE? query issued, the following tasks are performed behind the scenes:

- Path is tested (scanned) before connection.
- Failed test will automatically exclude the path (See Section 5.3.1.1.) and log a fault.
- Command re-runs automatically on a new available path.
- Process repeats until a successful test is confirmed (max 4 attempts).
- On a successful path verification, the signal is connected and a "0" is returned.

If the event that the CVE? query fails four consecutive tests, the following fault codes are logged and returned via the query:

- Fault 97: Bad input to midstage path
- Fault 98: Bad midstage to output path

The user may specify a midstage if auto-route is disabled (See Section 6.2.1 for details). However, if a mid-stage is specified failed attempts will not be reattempted or added to the exclusion list. The command is structured:

```
CVE? output,input,midstage
```

Examples:

Connect verify output 32 to input 12. Zero response indicates the connection was successful.

```
CVE? 32,12  
0
```

Connect verify output 96 to input 16. Fault code 97 generated indicates that four consecutive attempts failed to connect the crosspoint and it remains open. Bad input to midstage paths were detected and the crosspoints were added to the exclusion list (See Section 5.3.1.1. for details).

```
CVE? 96,16  
97
```

5.3.2. CONnect Command

This command is used to make a connection within the system.
CONnect ((From) (Output) *output*, (TO) (Input) *input* (, (ON)
((Module) *module* | Any)

Examples:

- CONnect from output 1, to input 1
- CON 1,1 (identical to the above)
- CON 1,1,any

5.3.3. DISconnect Command

This command is used to perform disconnections for crosspoints (crosspoints) which are currently connected.
DISconnect ((From) (Output) *output* (, (TO) (Input) *input*) (, (ON)
(Module) *module* | Any)

Examples:

- DISconnect from output 1, to input 1
- DIS all (disconnects all outputs to inputs)
- DISconnect output 1
- DIS 1,1

5.3.4. MAKe? Query

The MAKe? query is identical to the connect command except that it returns an integer response:

- zero: connect completed successfully
- non-zero: connect failed due to an execution error or a fault.

This is a departure from other queries which do not return a response if there was an execution error or a fault.



NOTE: Please refer to the BREak? Query for an example and additional information on the responses to this query.

5.3.5. BREak? Query

The BREak? Query is identical to the disconnect command except that it returns an integer response:

- zero: disconnect completed successfully
- non-zero: disconnect failed due to an execution error or a fault.

This is a departure from other queries which do not return a response if there was an execution error or a fault.

If the MAKE? or BREak? Queries are used in a compound command and there's an execution error or a fault, execution continues and a response is returned. This is a departure from the other commands which cause the rest of a compound command to be discarded if there's an execution error or a fault.

Examples:

Connect output 1 input 1; disconnect output 1 input 2; disconnect output 1 input 1

Connects output 1 to input 1 but when it attempts to disconnect from output 1 input 2, the ensuing execution error stops the rest of the command from executing and output 1 remains connected to input 1.

Make? output 1 input 1; break? Output 1 input 2; break? Output 1 input 1

Return:

0, 4, 0

The MAKE? and BREak? Queries alleviate a lot of the awkwardness that results from attempting to implement IEEE Standard 488.2 on serial and TCP/IP. Much of the standard is conceived around GPIB's ability to request attention from its controller. Lacking that ability, users of TCP/IP and serial are left with unsatisfactory alternatives.

A non-zero result indicates the need to check systematically the various status registers to determine the exact problem. It does not indicate the nature of the problem. The actual value returned is at best meaningless and at worst, misleading. A non-zero result is of

no value in determining what the problem is only in determining that there was a problem.

Reception of the response can be interpreted by the controller as an indication that the switch has completed the previous operation and is ready to accept the next command.

5.3.6. QUE? Query

This query is used to determine the connection status of a single crosspoint or all crosspoints.

QUEry? (from) (output)*output*,(TO) (input)*input*,(ON) (module)
module | all)

The response is the input to which the output is connected or 0 if it's disconnected. If an input is specified and the output is not connected or connected to a different input, it is flagged as an execution error. Queries regarding one output are checked against the module's response to a Verify command. Queries with the "all" parameter are "verified" against the system's current configuration memory.

Examples:

- QUE? 1 (the response would be the input number that is connected to the specified output port)
- QUE? 1,1
- QUE? all (the response would be the number of outputs being reported on, followed by the inputs that are connected starting with output 1 and ending with the last output of the unit)
- QUE? all , ,1 (returns connected outputs on module 1)
- QUE? all , ,1; QUE? all , ,2; QUE? all , ,3 (returns connected outputs on three installed modules)
- QUE? any,all (For fan-in systems, the response would be the number of inputs being reported on, followed by the outputs that are connected starting with input 1 and ending with the last input of the unit)

The following is an example response to the “que? all” command, which displays a single string from the output to the input connection.

Que? all response is 1,2

Interpreted as:

1 output,
output 1 is connected to input 2

5.3.7. GET? And SET Functions

These functions allow the user to get and/or set various properties and values of the system.

GET? *Property*

SET *property, value*

Various “properties” can be “set” with a value; Some “properties” “value” can be read. A separate table is updated as properties are added (and the list grows!). Note that each one behaves differently: consult the GET? And SET? Table (Section 5.5).

Examples:

- set 21, 1 (sets auto interlock on)
- get? 21 (gets current auto interlock status)
- get? 1 (gets number of outputs)
- set 1,1 (causes an execution error 12)
- set 29,0 (changes system to “backwards compatibility mode”)

5.3.8. LOCK and UNLOCK Commands

These commands allow the user to lock and/or unlock the front panel keypad.

LOCK *nnnn* (any number from 0001 – 9999)

UNLOCK

Use the lock and unlock commands as necessary. The code is not required to unlock the keypad remotely. Sending UNLOCK returns the front panel status to unlocked.

Examples:

- LOCK 2121 locks front panel keypad with code 2121
- UNLOCK unlocks front panel keypad

5.3.9. ETHernet? Query

This command is a query that returns the MAC address of the processor board. It is a unique alphanumeric string of hexadecimal numerals arranged as six (6) octets separated by colons.

Example:

ETH?

Might return a string like this (without spaces):

1 2 : 3 4 : 5 6 : 7 8 : 9 a : b c

NOTE: Each controller module has a unique MAC address. If the controller module is changed or replaced, the MAC address changes.

5.3.10. *SAV and *RCL Commands

These commands allow the user to save and recall complete crosspoint configurations in non-volatile memory locations in the system.

**SAV memory*

**RCL memory*

The user can save and recall complete crosspoint configurations. As a departure from 488.2, however, 0 is not acceptable. The highest number that is acceptable can be found by the GET? 28 query.

Examples:

- *SAV 99 (saves current crosspoint configuration to memory location 99)
- *RCL 12 (recalls crosspoint configuration saved in memory location 12)

5.3.11. FORceclose Command:

Force close command closes all TCP/IP ports. New sessions can be established immediately.

Example:

- FORceclose (closes all open TCP/IP ports)

From the front panel keypad, this command can be executed using STORE 224. Also, an exclamation point (“!”) followed by a linefeed (Ctrl-J if your Telnet program is not set up to automatically send it) on the Telnet port (23) can be used to force close the ports.

Background: Unlike web sites that must allow thousands (or sometimes millions) of simultaneous connections to a “port”, the CPU allows only one connection to each port.

When the host is done with its session, it tells the other device so that it can close its port and make it available to another session. In certain conditions, it’s possible for the host to close its session without the device finding out. (Examples: an Ethernet hub or cable is disconnected in mid-session and the host terminates its session.) In these conditions, the FORceclose command can be used to make the port available again.

Additionally, the inactivity timeout may be used to automatically close the port if no activity is detected after a user defined amount of time. See GET?/SET value 25 in Section 5.5 for more details.

5.3.12. RESet Command

This command performs a system reset.

RESet

Performs a system reset. If SET 30, 0 was performed prior, the system resets with factory defaults, otherwise, it performs a “normal” reset. If Autorestore is TRUE (Set/Get? 22), the connections are restored.

5.3.13. *IDN? Query

This query returns a string identifying the manufacturer, model and revision of firmware installed in the system. .

*IDN?

Returns an identification string of the format:

```
Universal Switching,pppppppp,s,rrrrrrrrrr\n
```

where pppppppp is the model code, s is 0 (in lieu of a serial number) and rrrrrrrr is the revision code. The model code and the revision code are extremely important for resolving support issues. Note that the revision code is subject to change with any firmware updates/revisions.

5.3.14. *TST? Query

This query performs a system self-test.

*TST?

The response is 0 if it completed successfully. A non-zero response indicates the number of modules that were not in their proper slots. Allow several seconds for the test to complete. As the result of the self-test:

Routing to modules that were removed or have stopped responding since the last reset or self-test generates an execution error 47 instead of generating a fault.

Modules that were inserted since the last restart or self-test now are used.

Interface setting made via the keypad or through SETs take effect.

5.3.15. *RST Command

This command is the crosspoint reset command.

*RST

This command clears all the crosspoint routings in all the modules. No other status registers are affected.

5.3.16. *CLS Command

This command clears registers as described below.

*CLS

This clears the interface's Last Error Registers, Event Status Register and the Status Byte Register (except for MAV, FLT and PSFLT) but not its queued responses. It has no effect on the other interfaces. As a departure from the standard, the Fault Queue is not affected. As a result, after the command, MAV, FLT and PSFLT reflects the status of their underlying conditions.

5.3.17. *STB? Query

This query returns the contents of the Status Byte Register.

*STB?

Returns the contents of the Status Byte Register. Note that bit 6 is the MSS bit and not RQS and MSS is cleared by the operation. (This is in contrast to the way GPIB serial polls clear RQS).

5.3.18. *ESR? Query

This query returns the contents of the Event Status Register.

*ESR?

Returns the contents of the Event Status Register (ESR). The register is cleared after the read. See below for details of the relationship between the ESR and the Last Error Registers.

5.3.19. *ESE Command

This command sets the value of the Events Status Register.

*ESE *n*

This sets the value *n* (*n* can be from 0 to 255) in the Event Status Enable Register (ESER). See below.

5.3.20. *ESE? Query

This query reads the Event Status Enable Register (ESER).

*ESE?

Returns the current value of the ESER.

5.3.21. *SRE Command

This command sets the value of the Service Request Enable Register.

*SRE *n*

Sets the value *n* (*n* can be from 0 to 255) in the Service Request Enable Register (SRER).

5.3.22. *SRE? Query

This query reads the value of the Service Request Enable Register.

*SRE?

Returns the current value of the SRER.

5.3.23. *PSC Command

This command sets the value of the PSC Register to *n*.

*PSC *n*

Set the value *n* (*n* can be 0 or non-zero) in the PSC register.

5.3.24. *PSC? Query

Sending this query reads the value of the PSC register.

*PSC?

Returns the current value of the PSC register as value of zero or 1.

5.3.25. *OPC Command

This command sets the OPC bit in the ESR.

*OPC

Sets the OPC bit in the ESR. This causes the SBR to be updated. The bit can only be cleared by *CLS or ESR?.

5.3.26. *OPC? Query

*OPC?

Immediately returns 1.

5.3.27. *WAI Command

This command is only included for compatibility to the 488.2 standard.

*WAI

Since the device does not support “over-lapped” commands, this command does nothing. It is included for compatibility with the standard.

5.3.28. POL? Query

The POL? (Port List) query is used to list the available TCP/IP ports currently available for Ethernet communication on the CPU. The response is 10 comma delimited numbers. Ports that are not defined are zero. For example, the factory default configuration is provided below:

```
7145,7147,7149,7151,7153,0,0,0,0,0
```

Note that the Standard Telnet Port 23 is not included in the list since it cannot be added or deleted.

5.3.29. POA Command

This POA (Port Add) command adds a user defined TCP/IP port for Ethernet communication on the CPU. The port may be any number from 1 – 9999. There is a maximum of 10 ports that can be available at any given time (in addition to the standard Telnet port 23). In the example below, port 800 is added.

```
POA 800
```

5.3.30. POD Command

This POD (Port Delete) command removes an available TCP/IP port for Ethernet communication on the CPU. The port may be any number from 1 – 9999. In the example below, port 1200 is deleted.

```
POD 1200
```

Note that the Standard Telnet Port 23 cannot be deleted.

5.3.31. LIN and LOUT Commands

The command is used to change the label of an input or output. The command is not case sensitive and must include all characters; LIN or LOUT:

```
LIN input, "label"
```

```
LOUT output, "label"
```

Example: Assign input 3 the label of Rx 3

```
LIN 3, "Rx 3"
```

Example: Assign output 1 the label of Tx 1

```
LOUT 1, "Tx 1"
```



NOTE: There is a 10 character length limit to labels. These commands work in tandem with the front panel options described in Section 2.12.2 and will update in real time.

5.3.32. LIN? and LOU? Queries

These queries are used to retrieve an input or output label. They are not case sensitive and may only include the first three characters.

```
LIN? Input|all  
LOU? Output|all
```

Example: Retrieve the label defined to input 3

```
LIN? 3
```

Response (using the previous example in Section 5.3.31)

```
Rx 3
```

Using the "all" parameter for either query will generate a comma delimited response for all inputs or outputs. An example is shown below.

Given:

```
LOUT 1 "Sat 1"  
LOUT 4 "Sat 4"<linefeed>  
LOUT 256 "Oscope"<linefeed>
```

```
LOU? All
```

Response:

```
Sat 1,,,Sat 4,.....,Oscope
```



NOTE: If a label has not been defined to a specific I/O the response of the LIN? Or LOU? Query of that input or output will be (No Label Assigned).

5.3.33. STL Command

The command is used to change the label of a saved switch configuration in memory. See Sections 2.11 and 9.6 for more details. The command is not case sensitive and must include all characters. Valid memory locations are 1 -120.

STL memory location, "label"

Example: Rename memory location 5 as Mission X

STL 5, "Mission X"

Example: Erase the label for memory location 5

STL 5, ""



NOTE: *There is a 10 character length limit to labels. These commands work in tandem with the front panel options described in Section 2.12.2 and will update in real time.*

5.3.34. STL? Query

The query is used to retrieve a memory configuration label. See Sections 2.11 and 9.6 for more details. It is not case sensitive and may only include the first three characters. Valid memory locations are 1 -120.

```
STL? Memory location|all
```

example: Retrieve the label defined to memory location 5

```
STL? 5
```

Response (using the previous example in Section 5.3.33)

```
Mission X
```

Using the "all" parameter will generate a comma delimited response for all inputs or outputs. An example is shown below.

Given:

```
STL 1 "Client Z"  
STL 5 "Mission Y"  
STL 120 "Test 5"
```

```
STL? All
```

Response:

```
Client Z,,,,Mission Y,,,,,Test 5
```



NOTE: If a label has not been defined to a specific memory configuration the response of the STL? Query for that location will be (No Label Assigned).

5.3.35. LOG? Query

The query is used to retrieve the contents of the event log. The event log tracks all activity from any of the remote interfaces, web GUI, and front panel touchscreen display. Events are timestamped and show the command or query and results. See 2.14.1.1. and 9.7 for more details. It is not case sensitive and may only include the first three characters.

LOG? All	Display all events
LOG? N	Display the most recent N number of events.
LOG? All,1	Display only errors
LOG? N,1	Display the most recent N number of errors.

Example: Show the last 4 events

```
LOG? 4
```

Sample Response

```
2015-09-09 09:34 RCL 1 _OK
2015-09-09 09:34 RST _OK
2015-09-09 09:34 RCL 2 _OK
2015-09-09 09:34 RST _OK
```

Example: Show the last 2 errors

```
LOG? 2,1
```

Sample Response

```
2015-09-08 10:31 GET? 101 _OUT_OF_RANGE
2015-09-08 10:30 CON 111, 1, 1 _MISSING_MODULE
```

5.3.36. TIM and TIM? Functions

The command and query are used to set or retrieve the time in the real time clock. Additionally, the system can be synchronized with an NTP server via the web interface. See Section 9.3 for details.

TIM 12,23,35	Set time to 12:23:35
TIM?	Returns current time

5.3.37. DAT and DAT? Functions

The command and query are used to set or retrieve the date in the real time clock. Additionally, the system can be synchronized with an NTP server via the web interface. See Section 9.3 for details.

DAT 9,10,15	Set date to 9/10/2015
DAT?	Returns current date using MM/DD/YY format

5.3.38. RFL? Query (Master / Remote Only)

The RFL? Query returns the faults that the master receives from the remote. The query works in a first-in / first-out fashion whereby the first error logged will be the first error reported by the query. If the RFL queue is empty, 0 is returned in response to the query.

The format is *aaffff* where *aa* is the two digit address or Network ID (i.e. 16 or 05) of the remote and *ffff* is the four digit fault code. For example, if the power cord were to become unplugged from the first power supply of the remote, an RFL? query sent to the master would return:

```
164200<linefeed>
```

It is recommended that the RFL? query be sent until the response is 0. This will ensure that the operator has retrieved all available faults logged in the remote.

5.3.39. REM? Query (Master / Remote Only)

The REM? query is used to determine the status of the remote unit. The query will return a comma delimited list of numbers representing the current state of the remotes. Similar to QUERy? ALL, the first number in the response will be the number of remotes reporting followed by the status of each remote. Status options include:

0="OK" 1="Missing" 2="Fault"

In the example below, there is one remote unit reporting and it's health is "OK"

```
1,0<linefeed>
```

5.3.40. TOP? Query

The TOP? Query is intended to be a top level view of the existing system architecture. With a variety of available functions, the TOP? query can provide the end user with helpful information in identifying installed modules, capacity, location, and functionality. The query response is built using JSON notation (JavaScript Object Notation).

The response hierarchy is defined below:

- Identification / CPU Information
 - Function – Includes information on the device function
 - Remotes – “0” refers to the local system. In a multi-system array, the quantity may be ≥ 1 .
 - Modules – Contains the module level information for the function branch.

5.3.41. UDES and UDES? Functions

The command and query are used to set or retrieve the User Description as shown in the web GUI’s LAN Configuration page.

UDES “My Switch”	Set user description to My Switch
UDES?	Returns current user description

5.4. Channel Classes

Classing is a feature that allows the user to assign inputs and outputs to one or many classes where only similarly classed I/O's can be connected. This feature is useful for applications where only a specific set of inputs will only ever connect to a specific set of outputs and any deviations could have adverse results.

There are 32 available classes which are identified using their class index number: 1 – 32. By default, all I/O's are assigned class 0 which allows for global access within the matrix.

The classing functionality can be accessed with the remote commands described in this section or the web GUI (See Section 9.12).

5.4.1.1. CIA and COA Commands

The CIA (Class Input Add) and COA (Class Output Add) commands can be used to add a class (or many classes) to inputs and outputs.

```
CIA input,class,module
COA output,class,module
```

 **NOTE: The module operand is only required in parallel systems with ganged mode disabled.**

 **NOTE: Attempting to connect crosspoints that are not in the same class will result in an execution error 24.**

Example:

CIA 9,10,1	Assign input 9 to class 10 on module 1.
COA 5,10,1	Assign output 5 to class 10 on module 1.
MAK? 5,9	Connect output 5 to input 9
0	The connection is made, no error.

Using the above example input 9 can be connected to output 5 because they belong to the same class.

Example:

CIA 9,10,1	Assign input 9 to class 10 on module 1.
COA 5,8,1	Assign output 5 to class 8 on module 1.
MAK? 5,9	Connect output 5 to input 9
24	The connection is not made (E:024)

In the previous example, the same connection cannot be made due to different class assignments. If either input 9 or output 5 were to be set to global (class 0) then the connection could be made again.

5.4.1.2. CID and COD Commands

The CID (Class Input Delete) and COD (Class Output Delete) commands can be used to remove a class from inputs and outputs.

```
CID input,class,module
COD output,class,module
```

Example:

CID 9,10,1	Remove input 9 from class 10 on module 1.
CID ALL,ALL,1	Remove all inputs from all classes on module 1.
COD 5,2,1	Remove output 5 from class 2 on module 1.
COD 2,ALL,2	Remove output 2 from all classes on module 2

5.4.1.3. CLL and CLL? Functions

The CLL (Class Label) command and query allows you to label a class for cross-reference purposes.

```
CLL index,"label"
```

Example:

```
CLL 5,"Plan B"      Assigns the label Plan B to class 5.
CLL 32,"WebbST"    Assigns the label WebbST to class 32.
```

The CLL? (Class Label) query allows you to read back the label of a class index.

```
CLL? Index
```

Example:

```
CLL? 32             Using the previous example, this
                    query will return WebbST.
```

```
CLL? ALL           This query returns a comma delimited
                    string of all the class labels. Classes
                    that are not labeled will not return
                    any data. Using the above example,
                    this query would return:
```

```
,,,,Plan B,,,,,,,,,,,,,,,,,,,,,,,,,,,,,WebbST
```

Where *Plan B* is the label of class index 5 and *WebbST* is the label of class index 32. All other class index's do not have a label.

5.4.1.4. CLI? And CLO? Queries

Class Index	Equation = $2^{(index - 1)}$	Decimal Value
1	2^0	1
2	2^1	2
3	2^2	4
4	2^3	8
5	2^4	16
6	2^5	32
7	2^6	64
8	2^7	128
9	2^8	256
10	2^9	512
11	2^{10}	1024
12	2^{11}	2048
13	2^{12}	4096
14	2^{13}	8192
15	2^{14}	16384
16	2^{15}	32768
17	2^{16}	65536
18	2^{17}	131072
19	2^{18}	262144
20	2^{19}	524288
21	2^{20}	1048576
22	2^{21}	2097152
23	2^{22}	4194304
24	2^{23}	8388608
25	2^{24}	16777216
26	2^{25}	33554432
27	2^{26}	67108864
28	2^{27}	134217728
29	2^{28}	268435456
30	2^{29}	536870912
31	2^{30}	1073741824
32	2^{31}	2147483648

The CLI? (Class Label Input) and CLO? (Class Label Output) queries allow the user to determine which classes a specific input or output are assigned to.

```
CLI? Input,module
CLO? Output,module
```

The response to the queries are bit-weighted values where each class index is assigned a decimal value using the formula $2^{(index-1)}$. The table to the left illustrates the decimal value for each class.

In cases where an input or output are assigned to multiple classes, the decimal value of each class will be added to each other. A simple decimal to binary conversion will identify the assigned class index.

For example, assume input 6 is assigned to classes 9, 17 and 26:

```
CLI? 6      would return;
33620224
```

Converted to binary, the response shows high values for bit positions 9, 17, and 26:

```
10 0000 0001 0000 0001 0000 0000
```

The ALL parameter may also be used to produce a comma delimited string for all available input or outputs. The example below assumes the module has 16 outputs

```
CLO? ALL      may return;
0,0,0,0,0,0,33620224,0,0,0,0,0,0,0,0,0,0
```

The response indicates that out of all 16 outputs, only output 6 is assigned a class and using the decimal to binary conversion we see that output 6 is assigned to classes 9, 17, and 26.

5.5. GET? And SET Values

Below is a table of the available properties that can be read and changed. Note that each one behaves differently so consult the table.

Code	Title	Access	Function
1	Outputs	RO	Largest output
2	Inputs	RO	Largest input
3	Modules	RO	number of modules for which the system is configured
4	Last query error	RO	last query error or zero (see note 1)
5	Slot that the module is in	RW	set: (see Note 2) Get: returns the slot where the module should be
6	Inputs on module	RW	set: (see Note 2) Get: returns the number of inputs on the module
7	Outputs on module	RW	set: (see Note 2) Get: returns the number of outputs on the module
8	Slots	RO	number of slots in the system
9	Module in slot	RW	set: (see Note 2) Get: returns module number in slot or 0
10	Module ID in slot	RW	set: (see Note 2) Get: returns ID of module in slot or 0
11	Algorithm	RO	14 – Parallel (See Section 6.2.2) 12 – End to End (See Section 6.2.1.1.) 8 – Tri-Stage™ (Refer to System Operators Manual)
12	Redundant mode or SD mode (See Section 10) (Master / Remote flag for F12831101_1508070618 only)	RW	0 – Redundant Mode 1 – SD Mode
13	SD Card Present?	RO	0 – Not Present 1 – Present
14	Dual State	RO	1 is alone, 2 is primary, 3 is secondary
15	Fault FIFO	RO	Returns next fault or zero if empty, see note 3
16	Last Execution Error	RO	last error or zero (see note 1)
17	Touchscreen Screensaver (See Section 2.14.4)	RW	0 – OFF 1 – ON
18	(Project)		
19	(Project)		
20	Ganged Modules	RW	0 is un-ganged, 1 is ganged
21	Auto Interlock	RW	auto interlock on (1) or off (0)
22	Auto Restore	RW	auto restore on(1) off(0)
23	Debug mode	RW	1: SPI traffic appears on Telnet port, 0: no traffic on port
24	Beep on Error	RW	beep on error (1) or silent (0) default is 1
25	Inactivity Timeout	RW	TCP/IP port inactivity timeout in seconds. Values: 0 – disabled (i.e. port remains open until closed by host or the FORceclose command) 1 – 28800 (8 hours) – number of seconds of inactivity until the port is closed. Values outside the range are coerced to 28800. The default value is 0 (disabled).
26	Power Supply 1	RO	Last status returned from PS1
27	Power Supply 2	RO	Last status returned from PS2
28	Memories	RO	number of "memories" available to *SAV or *RCL
29	Use 488.2	RW	use backwards compatibility mode (0)
30	System Integrity	RW	if anything other than 21930, system restores factory defaults on next reset

Code	Title	Access	Function
31	System cleared	RO	1 if system restored defaults on last restart
32	Last Command Error		last error or zero (see note 1)
33	"This" CPU's Current IP address (MS)	RO	nnn of nnn.XXX.XXX.XXX for current IP address
34	"This" CPU's Current IP address	RO	nnn of XXX.nnn.XXX.XXX for current IP address
35	"This" CPU's Current IP address	RO	nnn of XXX.XXX.nnn.XXX for current IP address
36	"This" CPU's Current IP address (LS)	RO	nnn of XXX.XXX.XXX.nnn for current IP address
37	"This" CPU's Current Subnet Mask (MS)	RO	nnn of nnn.XXX.XXX.XXX for current subnet mask
38	"This" CPU's current Subnet Mask	RO	nnn of XXX.nnn.XXX.XXX for current subnet mask
39	"This" CPU's current Subnet Mask	RO	nnn of XXX.XXX.nnn.XXX for current subnet mask
40	"This" CPU's current Subnet Mask (LS)	RO	nnn of XXX.XXX.XXX.nnn for current subnet mask
41	CPU-1 IP Address after reset (MS)	RW	nnn of nnn.XXX.XXX.XXX for IP address after next reset
42	CPU-1 IP Address after reset	RW	nnn of XXX.nnn.XXX.XXX for IP address after next reset
43	CPU-1 IP Address after reset	RW	nnn of XXX.XXX.nnn.XXX for IP address after next reset
44	CPU-1 IP Address after reset (LS)	RW	nnn of XXX.XXX.XXX.nnn for IP address after next reset
45	CPU-1 Subnet Mask after reset (MS)	RW	nnn of nnn.XXX.XXX.XXX for subnet mask after next reset
46	CPU-1 Subnet Mask after reset	RW	nnn of XXX.nnn.XXX.XXX for subnet mask after next reset
47	CPU-1 Subnet Mask after reset	RW	nnn of XXX.XXX.nnn.XXX for subnet mask after next reset
48	CPU-1 Subnet Mask after reset (LS)	RW	nnn of XXX.XXX.XXX.nnn for subnet mask after next reset
49	"This" CPU's Current gateway (MS)	RO	nnn of nnn.XXX.XXX.XXX for current gateway address
50	"This" CPU's Current gateway address	RO	nnn of XXX.nnn.XXX.XXX for current gateway address
51	"This" CPU's Current gateway address	RO	nnn of XXX.XXX.nnn.XXX for current gateway address
52	"This" CPU's Current gateway (LS)	RO	nnn of XXX.XXX.XXX.nnn for current gateway address
53	CPU-1 Gateway after reset (MS)	RW	nnn of nnn.XXX.XXX.XXX for gateway mask after next reset
54	CPU-1 Gateway after reset	RW	nnn of XXX.nnn.XXX.XXX for gateway mask after next reset
55	CPU-1 Gateway after reset	RW	nnn of XXX.XXX.nnn.XXX for gateway mask after next reset
56	CPU-1 Gateway after reset (LS)	RW	nnn of XXX.XXX.XXX.nnn for gateway mask after next reset
57	CPU-2 IP Address after reset (MS)	RW	nnn of nnn.XXX.XXX.XXX for IP address after next reset
58	CPU-2 IP Address after reset	RW	nnn of XXX.nnn.XXX.XXX for IP address after next reset
59	CPU-2 IP Address after reset	RW	nnn of XXX.XXX.nnn.XXX for IP address after next reset
60	CPU-2 IP Address after reset (LS)	RW	nnn of XXX.XXX.XXX.nnn for IP address after next reset
61	CPU-1 serial port settings	RW	Weighted value (See Note 10)
62	CPU-2 serial port settings	RW	Weighted value (See Note 10)

Code	Title	Access	Function
63	CPU-2 Subnet Mask after reset (MS)	RW	nnn of nnn.XXX.XXX.XXX for subnet mask after next reset
64	CPU-2 Subnet Mask after reset	RW	nnn of XXX.nnn.XXX.XXX for subnet mask after next reset
65	CPU-2 Subnet Mask after reset	RW	nnn of XXX.XXX.nnn.XXX for subnet mask after next reset
66	CPU-2 Subnet Mask after reset (LS)	RW	nnn of XXX.XXX.XXX.nnn for subnet mask after next reset
67	CPU-1 GPIB address	RW	1 – 31
68	CPU-2 GPIB address	RW	1 – 31
69	CPU-1 has serial port installed	RO	0 is no, 1 is yes
70	CPU-2 has serial port installed	RO	0 is no, 1 is yes
71	CPU-2 Gateway after reset (MS)	RW	nnn of nnn.XXX.XXX.XXX for gateway mask after next reset
72	CPU-2 Gateway after reset	RW	nnn of XXX.nnn.XXX.XXX for gateway mask after next reset
73	CPU-2 Gateway after reset	RW	nnn of XXX.XXX.nnn.XXX for gateway mask after next reset
74	CPU-2 Gateway after reset (LS)	RW	nnn of XXX.XXX.XXX.nnn for gateway mask after next reset
75	CPU-1 has GPIB port installed	RO	0 is no, 1 is yes
76	CPU-2 has GPIB port installed	RO	0 is no, 1 is yes
77	DHCP Client (Enable/Disable)	RW	0 is Disable (default), 1 is Enable
78	Network ID Number	RW	A number between 0 and 255. Default is "0". See note 6.
79	Power Supply Monitoring Disabling	RW	0, 1, 2 or 3. Where: 0 – both power supplies are monitored. 4 – power supply 1 is not monitored. 4 – power supply 2 is not monitored. 3 – no power supply is being monitored. See note 7.
80	Dual Fault Condition Mask	RW	A number between 0 and 15. Default is "0" for backwards compatible but a different factory default can be specified for each project. See note 8.
83	The Pole to which the module belongs	RW	Set: (See Note 2) Get: for a valid Pole, returns -1. For a module, returns the pole to which it belongs. For the case where Pole 0 is invalid, returns 0.
84	LSI Identification. Blinking on the front panel.	RW	0, or 1. Where: 0 – Off (default) 1 – On
85	CPLD Code Revision	RO	Returns current revision code of the CPLD firmware installed on the CPU.
86	Serial communication mode	RW	0 – 3. Where: 0 – RS-232C (default) 4 – RS-485 with termination 4 – RS-422A without termination 3 – RS-485 without termination 4 – RS-422A with termination
87	Intra-Matrix Module ID for parallel systems	RW	N = Module ID number. See the system Operations Manual for the list of module ID numbers assigned to the system. See Note 11.
88	Intra-Matrix	RW	0, 1, or 2. Where: 0 – No ganging (default) 4 – Series ganging 2 – Parallel ganging
89	Number of missing modules	RW	0 – None, fully populated system (See Note 9) N-X – Where : N= The number of modules in a fully populated system X= The number of modules currently installed.

Code	Title	Access	Function
90	NTP (Network Time Protocol)	RW	0 – NTP is disabled 1 – NTP is enabled
91	System Features for RWP5	RO	Returns a binary weighted value used by RWP5 to determine the systems available features including signal detent, crosspoint scan, etc. For internal use only.
92	Peer to Peer (P2P) Status (F2560FX01_1808311442 or greater)	RW	0 – P2P is disabled 1 – P2P is enabled but not other peer is detected. Could be a net ID mismatch 2 – P2P is enabled and this CPU is the Primary peer 3 – P2P is enabled and this CPU is the Secondary peer

Note 1: As long as the register’s corresponding bit in SESR is set, the GET? Command returns the last error. Once the SESR has been cleared (by the *ESR? Query), it returns the last error on the next call then clear itself.

Note 2: The SET determines which module or slot the next GET? References. Example: to find out which slots module 1 & 2 are in, the following may be used:

- set 5,1; get? 5; set 5,2; get? 5

Note 3: This is shared between all the interfaces. The Fault bit in the SBR clears once it is empty.

Note 4: The “Access” column designations are defined as:

- RW = Read and Write
- RO = Read Only

Note 5: Some systems have the capability to have two CPU’s installed. Those with only one CPU slot only have “CPU-1” installed.

Note 6: When a CPU receives a UDP packet, either addressed to it or as a broadcast on port 5417 of at least one character, the CPU responds with a UDP packet with the format “PROJECT_ xxx” where PROJECT_ is the eight character product code and xxx is the Network ID, with any leading zeros (Example: 11888101 007). The application for this is when DHCP is used. By sending out a broadcast packet addressed to port 5417, one can discover which IP addresses were assigned to what products by their DHCP server(s). If there are two systems with the same product code, the keypad can be used to assign different Network IDs.

In the 12689 (Master / Remote) switching system, all units with a Network ID of 16 is treated as a remote.

Note 7: Refer to the MAINFRAME section of the system manual to see additional information on power supply monitoring.

Note 8: The following is effective on all revisions greater than 0502221 100 regardless of how many processors are installed.

- GET?/SET register 80 is defined as the “Dual Fault Condition Mask.” It is readable and writeable. The factory default is 0 but a different factory default can be specified for each project.
- When the register is set to 0, it is “backwards compatible” and no difference is apparent from previous versions.
- The register is a 4 bit binary mask to enable new functionality. When a bit is set, its function is enabled and when it’s cleared, that function is disabled. The function of each bit is:
- Bit 0 (weight 1): If the CPU resets and does not detect another CPU, it logs fault 7900 if it’s in the top slot and fault 8000 if it’s in the bottom slot.
- Bit 1 (weight 2): Assuming that two processors had been working, if a CPU fails to get responses from the other CPU, it logs 8100 if it’s in the top slot and fault 8200 if it’s in the bottom slot.
- Bit 2 (weight 4): If a CPU that has been working with a second CPU detects that the other processor has reset for any reason including a power-on reset, it logs fault 8300 if it’s in the top slot and fault 8400 if it’s in the bottom slot. Note that in this case, it’s to be assumed that regardless of what state it was in, the processor that logged the fault is now the “primary.”
- Bit 4 (weight 8): If the top CPU resets and assumes “secondary” status, it logs fault 8500.

Example: assuming GET? 80 responds with 15 (the sum of 1 + 2 + 4 + 8) and two CPUs are installed and working (which you can verify with GET? 14 returning 2 from one processor and 3 from the other):

- remove the top processor: fault 8200 is logged.
- reinsert the top processor: faults 8400 and 8500 is logged.

These features allow the user to tailor which incidents should log faults. Examples (with the corresponding value to set in the register):

- A user with only one CPU likely does not want to be informed at every reset that the “other” CPU is missing (0).
- A user might want to know if one of the two CPUs has a “hard” failure vs a temporary fixable (3).
- A user might want to know if anything suspicious happened and may decide to discuss it with the factory (15).

Note 9: Modules must be installed contiguously. Changes take effect after the next self-test.

Note 10: A bit weighted value:

Bits 0-2: baud rate – decimal values

0: 1200 4: 19200

1: 2400 5: 38400

2: 4800 6: 57600

3: 9600 7: 115200

- Bit 3: reserved for RTS/CTS enable
- Bit 4: reserved for odd parity
- Bit 5: reserved for even parity
- Bit 6: reserved for 2 stop bits.

The case where both bits 3 and 4 are low is no parity.

The default is 3: 9600, no handshaking, no parity and one stop bit.

Note 11: To enable the Intra-Matrix function in parallel systems, you must first specify which module you want to enable it on. For example, your system has three 16x16 modules. You want to enable parallel ganging on module 3. You must send the following commands:

```
SET 87,3      (Specify module 3 to receive the next intra-matrix command)

SET 88,2      (Sets parallel ganging on the module specified in get?/set 87)
```

6. Control Information

This section provides a detailed description of the Status Byte Register control protocol and the System Switching Modes.

6.1. Status Byte Register

The Status Byte Register tracks and reports the operating status of the system using the IEEE Standard 488.2 control protocol.

6.1.1. Status Byte Register Layout and Description

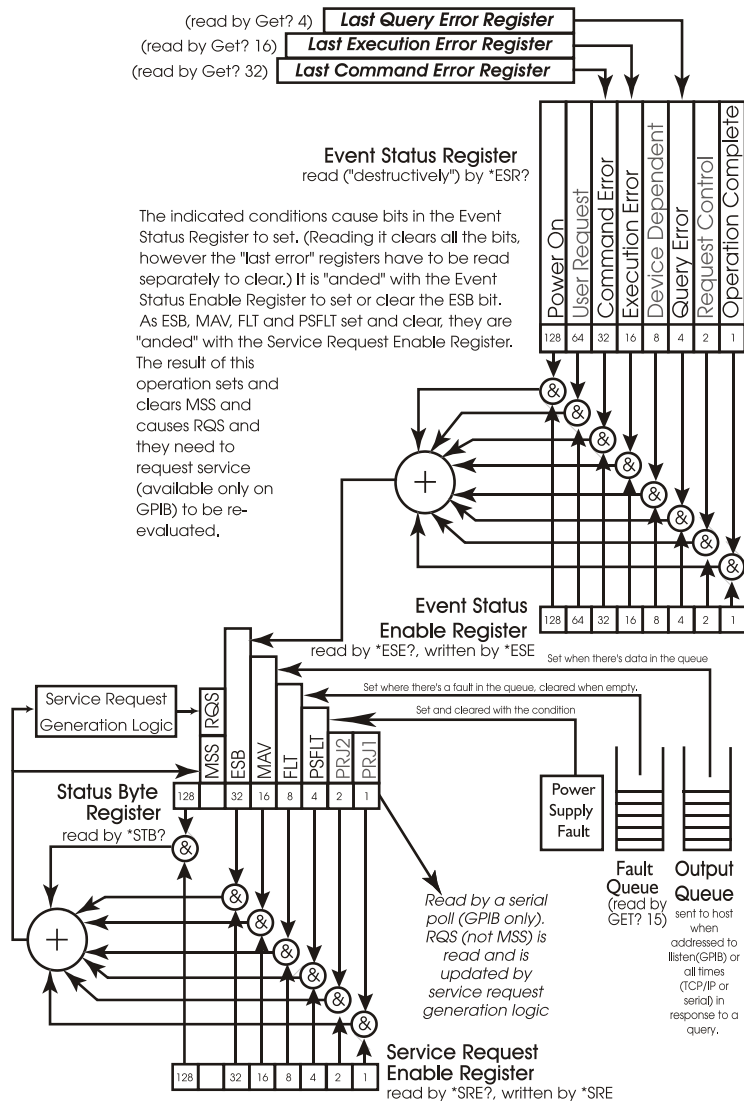

Italics indicate Universal Switching extensions to the model, dimmed items are not applicable to this product and are always 0.

6.1.2. The Status Byte Register (SBR)

The current bit status is summarized in the standard Status Byte Register (SBR). The SBR consists of the following bits with the following weights:

- **The standard Master Summary Status**
(MSS, numeric weight of 64) – this bit is dependent on the state of the other bits of the register and the current value of the Service Request Enable Register (SRER, see below for details on it and how the MSS is determined).
- **The standard Event Status Bit**
(ESB, numeric weight of 32) – this bit is dependent on the state of the Event Status Register (ESR) and the current value of Event Status Enable Register (ESER) (see below for both).
- **The standard Message Available bit**
(MAV, numeric weight of 16) – this bit is set when the Output Queue (see below) has responses for the host in it. It gets cleared when it's empty.
- **The Fault bit**
(FLT, numeric weight of 8) – this bit is set when there are faults recorded in the Fault Queue (see below). The usage of this bit is defined by Universal Switching.
- **The Power Supply Fault bit**
(PSFLT, numeric weight of 4) – this bit is set and cleared as faults are found or cleared in the power supplies.

The remaining bits (numeric weights 128, 2 and 1) are not defined by either 488.2 or Universal Switching Corp. They are currently always cleared. Universal Switching Corp reserves the right to use the undefined bits in the future or in project-specific applications. It is suggested that your host application mask these bits out.

6.1.2.1. Reading the Status Byte Register (SBR)

The SBR is read by issuing the *STB? Common command and interpreting the response. The response is a decimal number that, in practice, is between 0 and 127. The value indicates which of the five bits are set or cleared. The SBR is read-only.

On GPIB interfaces, the SBR is returned to the host in response to a serial poll. The 488.1 Request Service bit (RQS) is returned instead of the MSS bit in this case. For details, please consult the 488.2 standard.

On a technical note, serial polls are handled directly by interface ASICs without the intervention of the processor. As service requests are acted upon by the interface ASICs, the moment-by-moment status of RQS may be changed by the ASIC. MSS, on the other hand, is changed by the processor only. (Note that the serial poll causes RQS to clear but has no direct effect on MSS.)

6.1.3. The Service Request Enable Register (SRER)

The standard Service Request Enable Register (SRER) can be read by the common *SRE? Command and written by the *SRE command. With the exception of the bit with weight 64, each bit in the SRER corresponds to a bit in the SBR. In general, if at least one bit in the SRER is set and its corresponding bit in the SBR is also set, then MSS is set. Otherwise, MSS is cleared.

As an example, if the bit with weight 16 is set in the SRER, then MSS is set whenever MAV is set. Any of the following are examples of commands which set SRER that way: *SRE 16; *SRE 48; *SRE 56. The bit with weight 64 (which corresponds to the MSS itself) is ignored. In this implementation, all unused and undefined bits are always zero.

As an example, the response from *SRE 255; *SRE? is 56 unless one of the above mentioned bits has been designated to support a project specific function which shall be documented separately.

6.1.4. The Event Status Enabled Register (ESER)

In a similar situation, each bit in the standard Event Status Enabled Register (ESER) corresponds to a bit in the Event Status Register (ESR, see below). All eight bits in both registers are defined. If at least one bit in the ESER and its corresponding bit in the ESR are set, then the ESB bit of the SBR is set, otherwise the ESB is cleared.

The SRER is written to by the *SRE command and read by *SRE?

The Message Available (MAV) bit of the SBR tracks the status of the standard Output Queue. If there are responses waiting in the queue, MAV is set, if the queue is empty, MAV is cleared.

In the following example:

```
STB?;*STB?
```

The response could possibly be 0;16 or possibly 32;48 (if ESB was previously set). This is because the first command sees an empty queue while the second *STB? Sees effect of the first command in the queue on MAV. Using *STB? To poll MAV is futile. (In order to read the response from *STB?, you have to address the device to talk as if MAV is set.)

Again, GPIB behaves differently from serial or TCP/IP. The latter two immediately sends their responses back to the host on their own initiative. GPIB, on the other hand, waits until it is addressed to talk. See below for details on what happens if it's not address to talk prior to the arrival of the next command.

6.1.4.1. The ESER under GPIB Control

GPIB behaves differently from serial or TCP/IP. The latter two immediately send their responses back to the host on their own initiative. GPIB, on the other hand, waits until it is addressed to talk.

If the bit with weight 16 is set in SRER, then there is a request for service. Even without that, the host can still perform a serial poll and from the presence of the 16 in the SBR, it can infer that it needs to be addressed to talk.

The FLT bit of the SBR tracks the condition of the Fault Queue. The Fault Queue (see below) is a list of "faults" detected by the system.

Faults require operator and/or manufacturer intervention.

See below. The FLT bit can be monitored by the host to detect such conditions. Additionally, its corresponding bit in SRER can be set and thus cause a service request in the event of a fault.

6.1.5. The Event Status Register (ESR)

The standard Event Status Register (ESR) tracks several events. As mentioned above, it works in conjunction with the ESER to determine the value of the SBR's ESB bit. As set forth in 488.2, when a condition that is monitored by one of the bits is encountered, that bit is set and remains set until all the bits are cleared by:

- Reading the ESR with the *ESR? Common command
- The common *CLS command
- The common *RST command
- A processor reset

The ESR consists of the following bits and their weights:

- **Power-on (PON, weight 128)**
It is set when the power is turned on.
- **User Request (URQ, weight 64)**
It is not used and is always cleared.
- **Command Error (CME, weight 32)**
It is set when a syntax error (see below).is encountered in a command
- **Execution Error (EXE, weight 16)**
It is set when an execution error (see below) is encountered in a command.
- **Device Specific Error (DDE, weight 8)**
It is not used and is always cleared.
- **Query Error (QYE, weight 4)**
It indicates that the device was addressed to talk when the output queue was empty or that a new command was received before the output queue was emptied. Both cases are possible under GPIB, but highly unlikely with other interfaces.
- **Request Control (RQC, weight 2)**
It is not used and always clear.
- **Operation Complete (OPC, weight 1)**
Execution of the *OPC common command causes this bit to be immediately set. See the description of the *OPC, *OPC? And *WAI commands for details.

A command error (CME) results from the processor encountering a syntax error in a command. If the command is a compound command, all commands up to the offending command are still

scheduled to execute. The command with the error and any following commands are discarded.

As indicated previously, the CME bit of ESR is set. Additionally, a numeric code is placed in the Last Command Error register (see below) to indicate the nature of the syntax error.

An execution error (EXE) results from the processor attempting to execute an otherwise syntactically correct command that violates some condition. Some examples might be an output that's out of range or trying to connect to an output that's already in use when auto-interlock is not activated. Again, if it's a compound command, all commands up to the offending command are executed.

The command with the execution error and any commands following it are discarded. Again, the EXE bit of ESR is set and a numeric code is placed in the Last Execution Error register (see below).

A query error (QYE) sets the QYE bit of the ESR and causes a numeric code to be entered in the Last Query Error register (see below). It does not affect the parsing or execution of otherwise valid commands except to indicate that valid responses may have been lost.

The Last Command Error (LCE), Last Execution Error (LEE) and Last Query Error (LQE) registers and their behavior are specific to UNIVERSAL SWITCHING products. As indicated above, when one of the errors is encountered, a numeric error code placed in one of the registers and its flag in ESR is set. The error code can be read using the GET? Command with the code for that register.

The error code stays in the register until:

- It is replaced by a new error code
- The register is cleared with a *RST, *CLS or processor reset
- The register was read with a *GET? Command when its corresponding bit in the ESR is cleared.

6.1.6. Procedure for Recovering Errors

The suggested procedure for recovering these errors is to first read ESR with an *ESR?. If its bit in ESR is set, then perform a GET?. To recover the code.

6.1.6.1. Example Register Interaction

The following example should help illustrate the interaction between these registers and ESR.

- Suppose that the prior command has caused an execution error 1 (invalid output) and there were no other problems prior to it.
- Assume that LEE is read by the GET? 16 command. In that case, the following:

```
GET? 16; GET? 16; *ESR?; GET? 16; GET? 16; *ESR?  
Yield: 1;1;16;1;0;0.
```

- The first and second reads of the LEE both return 1 since nothing has happened to change it. Reading the ESR returns 16 (the set EXE bit) and clears it. The next read of LEE also returns 1, but since EXE is now cleared, LEE is also cleared. Finally, the last read of LEE and ESR show the results of the clearing.

6.1.6.2. The Fault Queue

The Fault Queue is a FIFO queue of system faults. Faults require intervention by either the operator (plug in the power supply that the janitor unplugged), or the manufacturer (repair the power supply that failed).

The queue can be read with repeated calls to the fault FIFO using the get? 15 command. If it's empty, get? 15 returns a 0. If the queue should fill-up, it over-writes the older entries in a "circular" fashion. If there are any entries in the queue, the FLT bit in SBR is set. Upon reading the last fault (if any) in the queue, FLT is cleared. **As a departure from 488.2, *CLS and *RST does not clear the queue or the FLT bit.** Only a complete system reset (or reading them as specified above) clears them.

6.1.7. Register Function Summary

To summarize the register functions:

- The overall status can be determined by reading SBR with the *STB? Command:
- A set PSFLT bit indicates a fault currently occurring in one of the power supplies. Note that is bit unique in that it sets and clears independently of host or keypad commands.
- A set FLT bit indicates the need to retrieve serious faults with the get? 15 command
- A set MAV bit indicates that there's data in the output queue
- A set ESB bit indicates that one or more of the bits in the ESR that were enabled in ESER are set.
- A set MSS bit indicates that one or more of the above three bits is set along with its corresponding bit in the SRER.
- The SRER is "anded" with the FLT, MAV and ESB bit of the SBR to generate the current MSS. It is set with *SRE and read by *SRE?
- The ESR contains several bits which in practice indicate the success or failure of a command to execute and respond. It is set by the various conditions and read by the *ESR? Command. Reading it clears it.
- The ESER is "anded" with the ESR to generate the SBR's ESB bit. It is written with the *ESE command and can be read with the *ESE? Command.
- Set CME, EXE or QYE bits in the ESR indicate that an error code is stored in LCE, LEE or LQE. These are read by GET? Xx.

The device maintains a separate set of registers for each interface (assuming there's more than one). In practical terms, this means that each interface can have, for example, a separate SRER or ESER. The Fault Queue, on the other hand, is common to all interfaces in the device.

Several conditions ultimately determine the current value of MSS. For example, setting the OPC bit of the ESR does not necessarily set MSS.

First OPC's bit in the ESER must be set in order for ESB to be set, then ESB's bit in the SRER must be set before the condition exists to set MSS.

As each change occurs, the value of MSS is re-evaluated and updated regardless of whether the change was an internal condition or a commanded change of one of the enable registers. On GPIB interfaces, as MSS is set or cleared, the need to request service or cancel a previous service request is also evaluated.

6.1.8. Commands to Evaluate and Control Status (488.2)

The following commands are used to evaluate and control the status of the device. Unless noted, these commands are part of the IEEE 488.2 standard command set. Recall that each interface maintains its own set of registers (but share the Fault Queue).

***STB?** – returns the value of the SBR at the start of the command. Note that the effect of the command on MAV won't be visible until after the command is executed. The most effective place for this command is as the last command of a compound command. Bits 7, 2, 1 and 0 are not used by this device at this time. Host programs should mask them out.

SRE *n – *n* is an integer value between 0 and 255. *N* is "anded" with 00111000 and set in the SRER. This corresponds to the bits that are in use in SBR. If at least one bit is set in SRER and its corresponding bit in SBR is also set then the MSS bit in SBR is set. Each time the SRER is changed (by this command), the value of MSS is re-evaluated.

***SRE?** – returns the value of the SRER as an integer between 0 and 255. Note that any unused bits are mapped out whenever a value is set in SRER. To illustrate the following command: SRE 255;SRE? Returns 56.

***ESR?** – returns the value of the ESR as an integer between 0 and 255. Per 488.2, the reading of the ESR clears it.

***ESE?** – returns the current value of the ESER as an integer between 0 and 255. The value of ESER does not change.

ESE *n – sets the integer value *n* (between 0 and 255) into ESER. If at least one of the bits in ESER is set at the same time as its corresponding bit in ESR, then the ESB bit in SBR is also set. Each time ESER is changed (by this command), the value of ESB and MSS are re-evaluated.

***PSC n** – sets the integer value n (0 or 1) in the PSC register. If the register is 1, ESER and SRER are cleared on each restart. If its value is zero, ESER and SRER are preserved. One possible use of this feature is that by setting the PON bit in ESER, setting the ESB bit in SRER and setting 0 in PSC, the device requests service from its controller on power-up. (This works only on GPIB.)

***PSC?** – returns the current value of PSC

***CLS** – This clears the interface's Last Error Registers, Event Status Register and the Status Byte Register (except for MAV, FLT and PSFLT) but not its queued responses. It has no effect on the other interfaces. As a departure from the standard, the Fault Queue is not affected. As a result, after the command, MAV, FLT and PSFLT reflects the status of their underlying conditions.

***RST** – This command clears all the crosspoint routings in all the modules. No other status registers are affected

6.1.8.1. Commands to Evaluate and Control Status (non 488.2)

The following commands are used to evaluate the status of the device. They are in addition to IEEE 488.2 commands and their functionality is not defined by that standard.

GET? 15 – returns the oldest entry in the Fault Queue and will always be at least a three digit number. The last two digits in the number are undocumented diagnostic codes. The first digit(s) in the number and their meanings can be referenced in the error code list. If the queue is empty it returns 0. If there are entries in the queue, the FLT bit of SBR is set. Reading the last entry causes the FLT bit to clear and for MSS to be evaluated.

The following three read-only registers behave differently from the others properties that can be read with the GET? Query commands. Upon detecting an error of one of the above types, its corresponding flag in the ESR is set and the error is recorded in the register. (Any previous, unread error is over-written.) At this point, the register can be read with the GET? Query. Once the ESR is cleared or read (which clears it), the Last Error Registers clear after the next time they are read

GET? 4 – returns contents of the Last Query Error Register

GET? 16 – returns contents of the Last Execution Error Register

GET? 32 – returns contents of the Last Command Error Register

6.1.9. Overlapped Processing

The due to the nature of switching operations, all commands are processed sequentially. There is no overlapped processing. As such the following commands are included for compatibility with other 488.2 devices. They provide no added functionality beyond performing their required functions in as little time as possible.

Per the standard these operations wait while the no-operation-pending flag is false. On devices that have only sequential operations, the standard calls for this flag to always be true.

***WAI** – does not have any effect.

***OPC?** – returns “1”.

***OPC** – sets the OPC bit in the ESR. The values of ESB and MSS are re-evaluated.

6.2. System Switching Mode

The switching system can be enabled in two modes; AUTO-ROUTE mode or GANGED mode. The mode of the system affects the allowed syntax for the following operational commands:

- **CONnect** Makes a connection within the system.
- **DISconnect** Makes a disconnection within the system.
- **QUERy** Queries the complete system or a single crosspoint.

Depending upon the system mode, these commands may or may not require a module number in the command syntax entered by the user.

6.2.1. Auto-Route Mode

The AUTO-ROUTE mode automatically routes the command entry without the need to address a specific module number.

6.2.1.1. Output End to End System

The output end-to-end system assumes a single configuration that may comprise one or several modules. The total number of outputs and inputs of the system is the result of all modules combined. The system is programmed to route automatically the command entry to the correct module without the need to address a specific module number. However, for diagnostic purposes only, the user has the option to specify a module when querying the system. The keypad on this type of configuration automatically displays the following:

“AUTO-ROUTE”

Output End-to-End systems are configured in AUTO-ROUTE mode.

6.2.2. Parallel Operation

PARALLEL operation requires a module number in the command string to correctly interpret the command entry. The PARALLEL system is configured to control each module individually. When controlling each module individually, if ALL is specified in the command syntax, the command operation is performed collectively on all modules.

- When Module 1 is specified in the command syntax, the command operation is performed on Module 1.
- When Module 2 is specified in the command syntax, the command operation is performed on Module 2.
- When Module 3 is specified in the command syntax, the command operation is performed on Module 3.

6.2.3. Ganged Mode

GANGED Mode is a commonly used switching mode in digital clock/data applications though is not limited to digital switching systems. This operational mode does not require the specific module operand to correctly route the command entry. In a typical digital application, one switching module will be used to route clock signals while another module of the same model will be used to route corresponding data signals on the same I/O paths in order to match signal phase. The user only needs to command which input and output should be connected and the switching system will perform the action on both the clock and data module.

The command operation is performed collectively on all GANGED modules. The purpose of ganged mode is to save the user some front panel keystrokes and to streamline control software. Depending on the customer application, some switching systems are shipped from the factory with the ganged mode enabled as the default. Other systems may not have this option enabled by default but may be available. To enable or disable ganged mode, see Section 2.14.6.2.

Note that if GANGED is enabled, the entry of a single module is not possible and ALL is assumed. The keypad on this type of configuration automatically displays the following:

“GANGED”

For systems configured in GANGED mode, POLES or “virtual modules” may be formed to assist the programming and operation of the system.

6.2.4. Poles (Virtual Modules)

The concept and functionality of POLES or “virtual” modules is summarized as follows:

- POLES are used only in PARALLEL systems.
- POLES are “virtual” modules that gang together two or more “actual” modules. The system can have as many POLES as required.
- Operation on a POLE affects all the module’s members of the POLE.
- Any module member of a POLE maintains its independent functionality.

For example, in a system with three modules, Module 2 and Module 3 may be identified as POLE 4. POLE 4 is addressed in command syntax as “Module 4”. Command operations specifying “Module 4” simultaneously perform the command operation on Module 2 and Module 3. However, any module maintains its independent functionality and may be addressed as follows:

- When Module 1 is specified in the command syntax, the command operation is performed on Module 1.
- When Module 2 is specified in the command syntax, the command operation is performed on Module 2.
- When Module 3 is specified in the command syntax, the command operation is performed on Module 3.

7. Error Code List

The following is a standard list of error codes. Please note that some codes may not be applicable to all types of equipment or configurations. See notes at the bottom of the table for applicability and other information.

The types of errors are divided into four classifications:

- | | |
|------------------|----------------|
| 1. E = Execution | 3. F = Fault |
| 2. Q = Query | 4. C = Command |

All errors are 1 or 2-digits (except faults which are 3 to 4 digits). The first two digits are defined in the table below. The last two digits are application specific. Contact the factory for a specific definition of the fault code. Please provide your system firmware model and revision code.

Error	Type	Description
1	E	Invalid output parameter
2	E	Invalid input parameter
3	E	Invalid command
4	E	Output already connected to different Input
5	E	Blocking input connected already
6	E	Output not connected to anything
7	F	Corsspoint self test failed
8	E	Memory location not used yet
9	E	Bad command argument
10	E	Invalid slot parameter
11	E	Not a valid "GET" property
12	E	Not a valid "SET" property
14	E	Store (*SAV) or Recall (*RCL) out of range
15	E	Set or Get not defined for this system
16	F	Remote missing (Master only). See note 1.
17	F	No top route (Master only). See note 1.
18	F	No bottom route (Master only). See note 1.
19	F	Excessive faults in remote. See note 1.
21	E	Command length error
22	E	No mid-stage available
24	E	Classing mis-match (See Section 5.3.38)
26	E	Non existing module
27	E	Coil error from relay(s)
28	E	Memory location for "*SAV" temporarily not available. See note 2.

Error	Type	Description
31	Q	Lost command (new command sent before last response read)
32	E	Wrong mid-stage addressed – Partial ganging (parallel). See note 3.
33	E	Path is not excluded. See note 3.
34	E	List is full, no more exclusions. See note 3.
35	E	Path is excluded. See note 3.
40	F	Power supply #1 fault
41	F	Power supply #2 fault
42	F	Power supply #1 is missing
43	F	Power supply #2 is missing
47	E	Missing module in system
50	F	SPI “time-out” error caused by module not responding
51	F	Communication timeout. See Note 1
52	F	SPI error (internal)
53	F	SPI error (internal)
54	F	SPI error (internal)
55	F	SPI error (internal)
56	F	SPI error (internal)
57	F	SPI error (internal)
58	F	SPI error (internal)
59	F	SPI error (internal)
60	F	CDMux Callback missing. Contact tech support.
61	C	Wrong 1 st argument
62	C	Wrong 2 nd argument
63	C	Wrong 3 rd argument
64	C	Blank program message unit (IEEE-488.2 standard term)
65	C	Firmware issue (consult factory)
66	C	Invalid command header (IEEE-488.2 defined)
67	C	Command has too many arguments
68	C	Command has too few arguments
73	Q	Addressed to talk but has no response
74	F	US-Link Timeout / Peer to Peer command failure
75	F	US-Link address wrong
76	F	US-Link bad command
77	F	US-Link remote has a fault
78	F	US-Link remote has an ongoing fault condition
79	F	Dual transition Fault CPU1 (Top) is alone
80	F	Dual transition Fault CPU2 (Bottom) is alone
81	F	Dual transition Fault CPU2 (Bottom) stopped responding
82	F	Dual transition Fault CPU1 (Top) stopped responding

Error	Type	Description
83	F	Dual transition Fault CPU2 (Bottom) reset
84	F	Dual transition Fault CPU1 (Top) reset
85	F	Dual transition Fault CPU1 (Top) came up as secondary
86	F	Invalid mid-stage parameter. See note 3.
88	F	Dual processor firmware mismatch
89	F	String overrun. Contact technical support.
90	F	Contact technical support.
91	F	Contact technical support.
92	F	Contact technical support.
93	F	Contact technical support.
94	F	Contact technical support.
95	F	SD Card is required but missing or not recognized.
96	F	Contact technical support.
97	F	Bad input to midstage path during CVE?
98	F	Bad midstage to output path during CVE?
99	F	Signal detect mismatch

Note 1: Apply only to Master/Remote switching systems.

Note 2: If error 28 does occur, try splitting the compound command with all those QUERY? ALL commands and the *SAV into two or more commands.

Note 3: Errors 32, 33, 34, 35 and Fault 86 apply only to Tri-stage™ switching system.

**THIS PAGE WAS
INTENTIONALLY LEFT
BLANK**

8. C3-001 Remote Control Assembly

The latest generation CPU, the C3-001 provides the brain and the remote control capacity of the switching system. The CPU offers a host of new features and is compatible with all Universal Switching Corporation switching systems. Below is a list of key features:

- SNMP v1, v2 Supported
- 10/100BaseT Ethernet
- Multi-Serial Control (RS-232C, 422, 485)
- USB 2.0 (Type-A) for serial control
- Non-Volatile Flash Memory
- Firmware updates over Ethernet
- Field Upgradable Flash



8.1. Remote Control Interfaces

This section describes the various remote control interfaces, their pin-out and required settings.



NOTE: *In the 2RU mainframe, the remote interfaces are fed to the rear panel of the mainframe and are not active on the front panel of the CPU. See Section 2.14.5.2. for more details.*

8.1.1. 10/100 Ethernet

The Ethernet port is designed per standard 10/100-Base-T specifications, and has standard pin assignments. For reference, the table below describes the pin assignments

Pin	Signal Assignment
1	Tx +
2	Tx -
3	Rx +
4	No Connect
5	No Connect
6	Rx -
7	No Connect
8	No Connect

8.1.1.1. TCP/IP Control Ports

The C3-001 offers a dynamic range of available TCP/IP ports that may be user-defined. The maximum amount of ports that can be set is 10. The factory default active ports are 7145, 7147, 7149, 7151, and 7153.

Refer to Sections 5.3.28, 5.3.29, and 5.3.30 for information on adding or removing a port from a remote interface. The web GUI (Section 9.2) may also be used to edit the available ports.

8.1.1.2. Default IP Address

When a unit leaves the factory it is configured in DHCP mode. When powered on, the CPU will send a broadcast request. If available, a DHCP server will automatically assign an IP address to the CPU as defined in the user network. In absence of a DHCP server, a Link Local address will be resolved per [IETF RFC 3927](#).

8.1.1.3. Changing the IP Address

The IP address and other Ethernet settings may be changed through the system's front panel (See Section 2.14.5.1.) or by using the GET?/SET values 41-48, 53-56 (See Section 5.5).

8.1.2. Serial

The C3-001 offers a standard DB-9 serial port with multi-serial interfaces (RS-232C, RS-422A, and multi-drop RS-485). Additionally, the CPU has a USB 2.0 (Type-A) interface that may be used for remote control.

8.1.2.1. DB-9 Connector

8.1.2.1.1. Changing the Serial Mode

The C3-001 CPU is delivered in the default state using the RS-232C control protocol. RS-485 and RS-422A are also available. The serial mode can be changed through the front panel (See Section 2.14.5.1.2.) To change the serial control mode remotely, use the GET?/SET value 86 over one of the remote interfaces. See Section 5.5 for more details. The current serial mode is identified by the MODE LED on the CPU. See Section 8.4 for identification.

8.1.2.1.2. Setting the RS-485 Address

When in the RS-485 control mode, the unit needs to have an address. The factory default address is 0. The Network ID is used as the RS-485 address. Refer to Section 2.14.5.1.1 for more details.

When addressing a system over RS-485, all commands must be preceded by the systems RS-485 address.

8.1.2.1.3. Serial Port Pin Assignment

The DB-9 serial port has the following pin assignment:

Pin	RS-232C (DCE) Mode	RS-422A Mode	RS-485 Mode
1	Not Used	Transmit Data – (out)	Not Used
2	Rx Data (output)	Transmit Data + (out)	Not Used
3	Tx Data (input)	Receive Data + (in)	Data +
4	Not Used	Receive Data – (in)	Data -
5	Ground	Ground	Ground
6	Not Used	Clear To Send - (in)	Not Used
7	RTS (input)	Clear To Send + (in)	Not Used
8	CTS (output)	Ready To Send + (out)	Not Used
9	Not Used	Ready To Send - (out)	Not Used

8.1.2.2. USB (2.0)

The USB connector on the C3-001 supports version 2.0 and is Type-A. It may be used as a remote control port to interface with a PC using a terminal program such as HyperTerminal.

It may also be used to interface with our USB to GPIB adapter, P/N: GPIB-USB-006. Note that the USB port on the C3 CPU must be configured to accept the GPIB adapter See GET? / SET value 75 and 76 in Section 5.5 for details.

8.2. Firmware Updates

The C3-001 CPU may be updated over Ethernet. This new feature negates the requirement of additional cabling and allows for firmware updates to systems in unmanned locations.

If a firmware update is available or requested, a complete firmware upgrade package will be made available on our support forum website uswi247.com. The upgrade package contains all the files and instructions required to update the CPU's firmware driver. Email Technical Support at support@uswi.com or call at +1 (818) 381-5111 for firmware requests or assistance.

8.3. Restore to Factory Defaults

The below procedure will clear the CPU memory and restore the CPU to its factory default settings:

1. On the front keypad, enter STORE → 267 → ENTER.
Displays: "KEYPAD UNLOCKED"
2. On the front keypad, enter MENU → Lock Screen → 7671 → ENTER.
Displays: "SET OK"
3. Cycle power to the system. Note that if the system receives another command from either the front keypad or remote interface before the power has been cycled or in between steps, the procedure needs to be restarted from the beginning.

8.4. C3-001 CPU LEDs

The C3-001 CPU has many LED indicators that provide the following information to the operator:

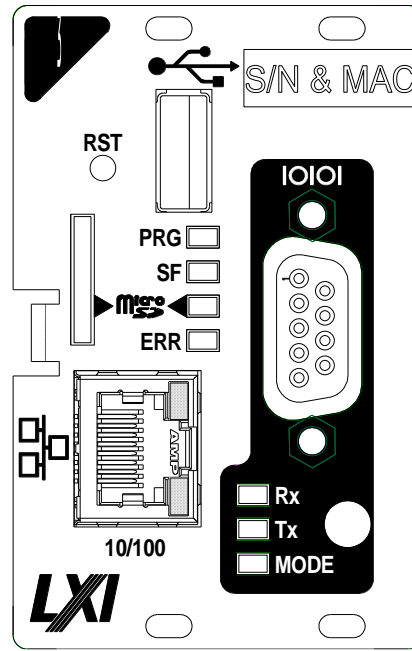

LED	Color	Description						
PRG	RED	Programming LED. On when the CPU is in Programming Mode.						
SF	GREEN	Flashes to indicate that data is being written to serial flash.						
	GREEN	Flashes to indicate that data is being written to the microSD card						
ERR	RED	On to indicate an execution error or fault condition within the system.						
10/100	GREEN	Data Transmit: Blinks when transmitting data over Ethernet.						
10/100	YELLOW	Packet Detect: Solid yellow when packets are detected on the network.						
Rx	GREEN	Flashes to indicate data is being received over the DB-9 serial port.						
Tx	YELLOW	Flashes to indicate data is being transmitted over the DB-9 serial port.						
MODE	GREEN	Indicates the current control mode of the DB-9 Serial Port: <table border="1" data-bbox="527 1669 1031 1785"> <tbody> <tr> <td>OFF</td> <td>RS-232C</td> </tr> <tr> <td>ON</td> <td>RS-485</td> </tr> <tr> <td>Blinking</td> <td>RS-422A</td> </tr> </tbody> </table>	OFF	RS-232C	ON	RS-485	Blinking	RS-422A
OFF	RS-232C							
ON	RS-485							
Blinking	RS-422A							

8.5. SNMP

The C3-001 currently supports Simple Network Management Protocol (SNMP) v1, v2 and v3. It is ideal for network environments that monitor network-attached devices for conditions that warrant administrative attention.

Universal Switching equipment that includes a C3-001 CPU will also include a set of Management Information Bases (MIB's) that describe the structure of the management data and includes all relevant object identifiers (OID). The MIB's are included on the System Resource Disc that ships with the equipment. All SNMP supported equipment use the same sysSettings.MIB and sysTrap.MIB. A system specific MIB is also included. Contact support@uswi.com for the latest copies of MIB's for your equipment.

8.5.1. SnmpB Browser

The examples and screenshots used for Section 8.5 were taken from an SNMP MIB browser titled SnmpB. It is an open source platform and is available at the link below:

<http://sourceforge.net/projects/snmpb/>

The below sections walk the user through preliminary configurations in SnmpB in order to communicate with the Universal Switching Corporation device.

8.5.1.1. Load Modules

Copy the three MIB files to the SnmpB programs mibs folder located in the Program root directory, C:\Program Files (x86)\SnmpB\mibs

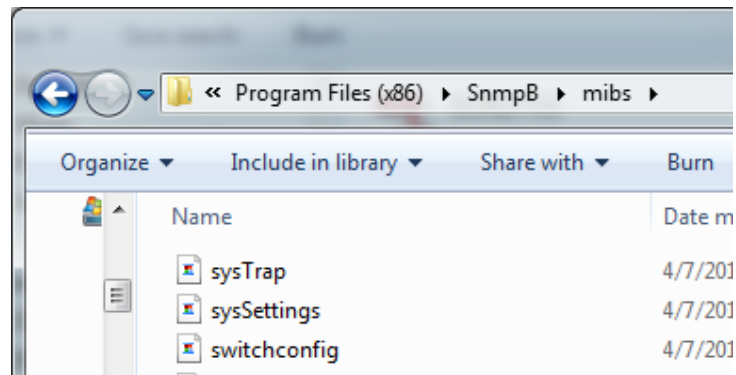

Open the SnmpB software and go to the Modules Tab. Under the *Available MIB modules* window, the three MIB's will be at the bottom of the list. Select each one and using the right hand facing arrow, move them over to the *Loaded MIB modules*. Note that additional MIB modules will automatically be added if there are inter-dependencies.

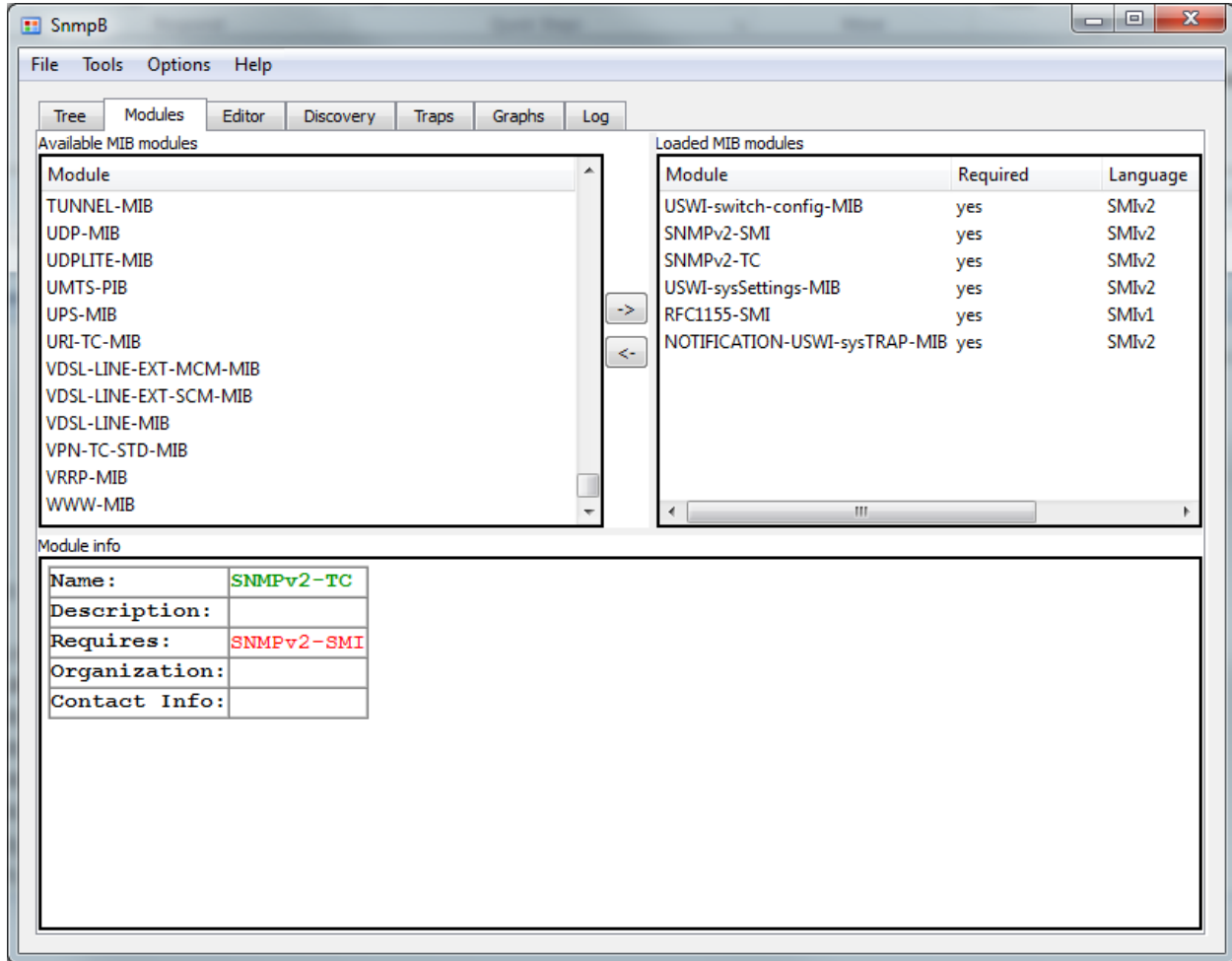

8.5.1.2. General Properties

Go to the Tree tab. Using the Remote SNMP Agent drop down menu, select localhost then select the icon for properties.

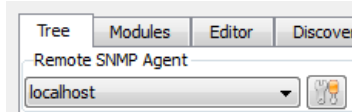

In the General Properties dialog box, enter the IP address of the Universal Switching Corporation switching system and leave the other options set to default settings:

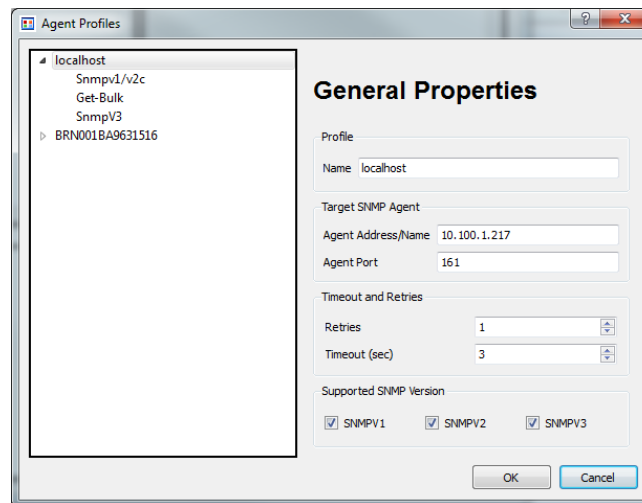

Expand the localhost menu and select Snmpv1/v2c. Set both *Read community* and *Write community* to public (factory default) or to your custom setting as defined in the web GUI (See Section 9.2). Click OK when done.

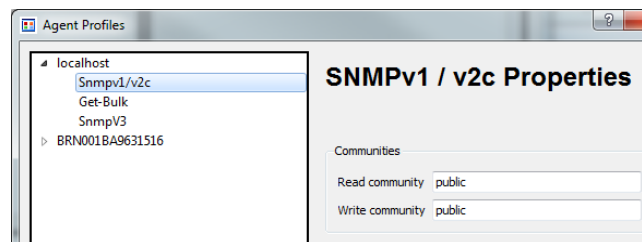

Now you should be back on the Tree tab. Select the bubble option for SNMPv2c:

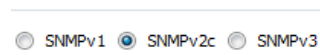

8.5.1.3. Set Trap Host

Currently, the C3-001 CPU supports up to five simultaneous trap hosts. To add your PC to the trap host list, expand the MIB Tree to sysSettings.

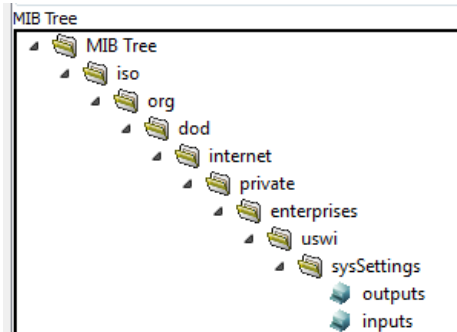

At the bottom of the sysSettings list you will see trapHostIP. Expand it out to trapHostAddress. Right click on that object and select Set

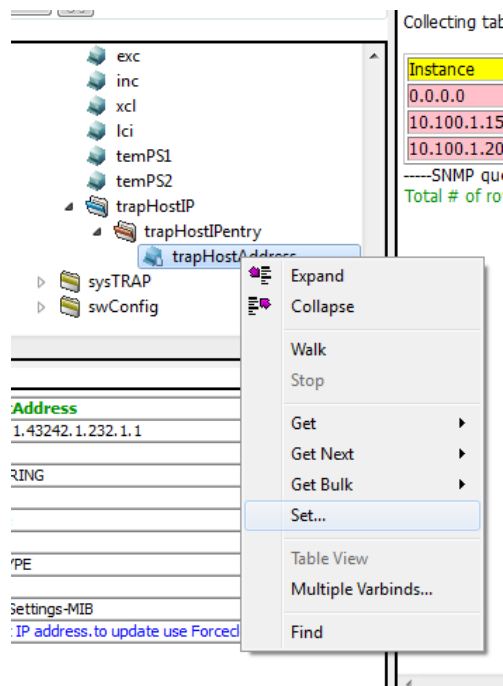

In the Select Instance dialog box, double click on 0.0.0.0

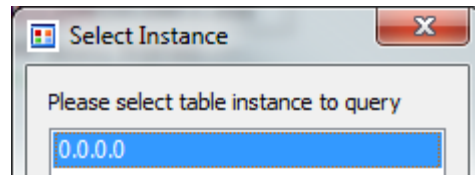

In the Set dialog box, the default Syntax drop down should be set to IP address. In the Value field, type in the IP address of the trap host you want to add then select OK. The Query Results window should show that the trap host was added successfully.

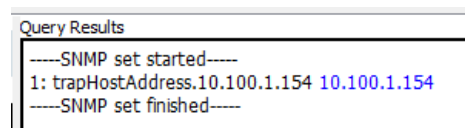

At this point, all settings are complete to begin using the SNMP interface to communicate with the switching system.

8.5.2. sysSettings.MIB

The sysSettings.MIB is displayed in the MIB Tree. It includes a corresponding list of OID's to the GET and SET value table (Section 5.5). Depending on the purpose of the function, it may be read only or read-write. The sysSettings.MIB is common to all SNMP supported Universal Switching products.

You may right click on any parameter and select get to send the query and retrieve the result. In the example below, we send a get query to the outputs OID. The system returns that there are 64 available outputs.

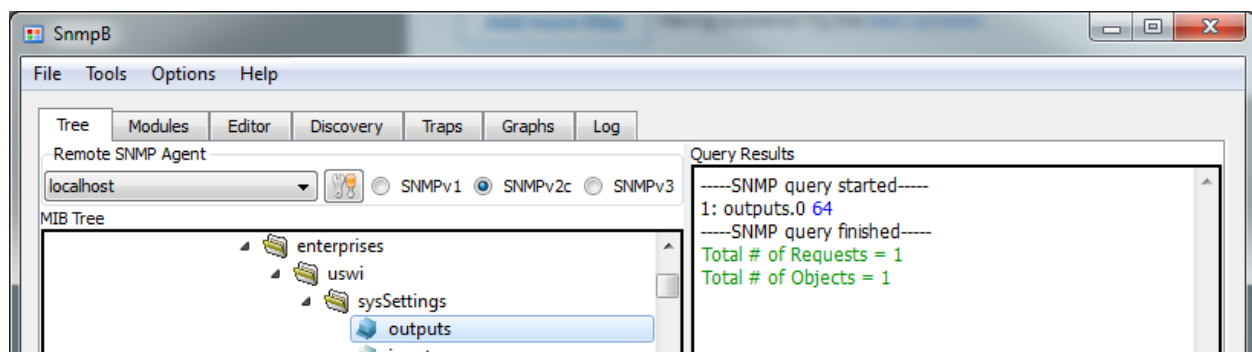

8.5.3. sysTRAP.MIB

The sysTRAP.MIB is displayed in the MIB Tree. The OID's are not interactive. They are simply there to provide the necessary structure to the SNMP manager when a trap is initiated by the switching

system. Fault conditions or execution errors will generate a trap. The sysTRAP.MIB is common to all SNMP supported Universal Switching products.

You may view traps that have been sent by the switching system by selecting the Traps tab. The traps tab will list the traps in sequential order with the oldest trap listed at the top of the list. When you select a trap from the list, the trap content and trap info is displayed below. The error code is displayed as part of the Community data in the Trap Content. Error codes directly correlate with the Universal Switching error code list in Section 7.

In the example below, a command was sent to connect input 1 to output 65. The trap error code 1 was returned indicating that 65 is an invalid output parameter (This example system only has 64 outputs).

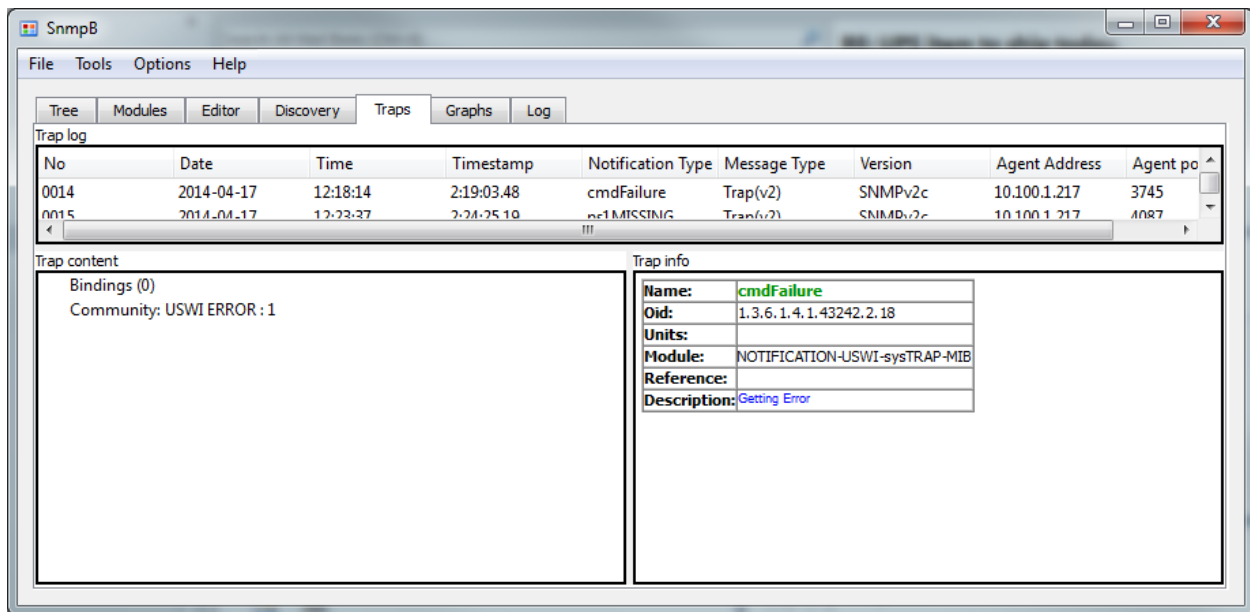

8.5.4. swConfig.MIB

The swConfig.MIB is displayed in the MIB Tree. In addition to the standard system OID's, It may also contain the swCMD OID and connectionTable OID which are both optional and available for upgrade. The swConfig.MIB is system specific and will contain the switching system's part number as the Object Identifier.

In the example below, the Object Identifier is the 12837-S6432-0.

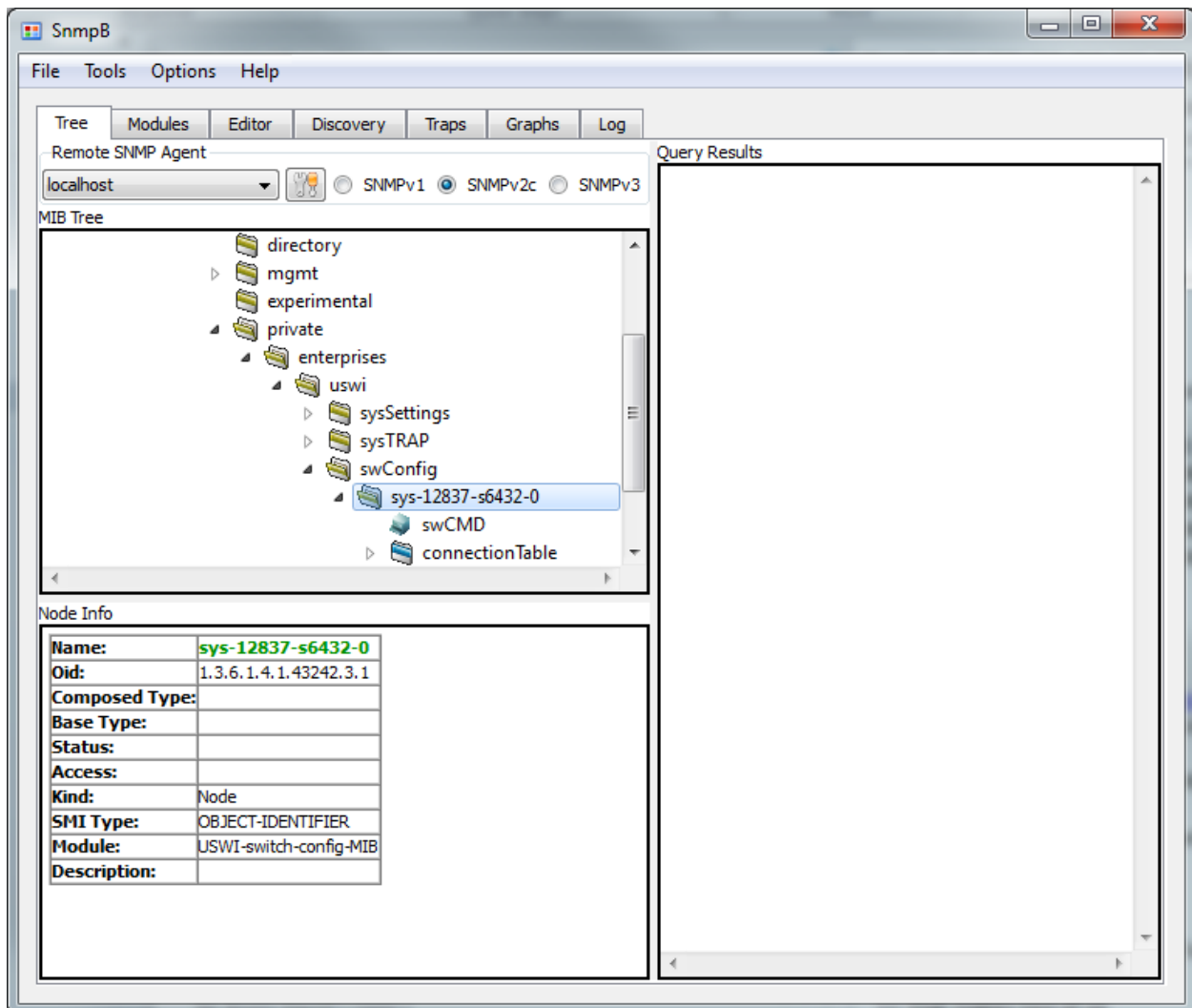

8.5.4.1. swCMD

The optional swCMD object is used to connect and disconnect crosspoints in the switching system. Right click on the swCMD object and select set. In the Set dialog box, the default Syntax is Octet String. Type in the command and click OK.

In the example below, output 2 is being connected to input 3:

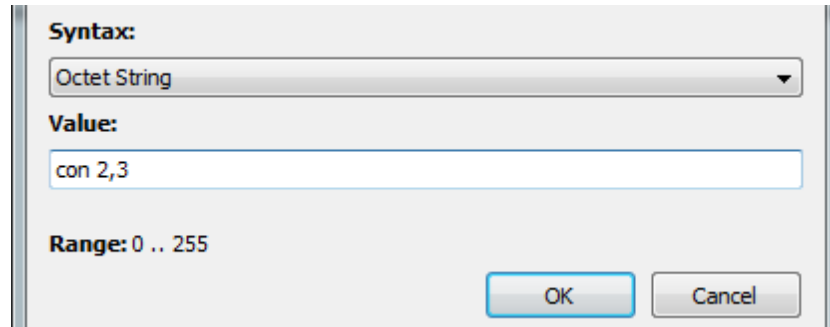

Syntax:
Octet String

Value:
con 2,3

Range: 0 .. 255

OK Cancel

Note, compound commands are not supported.

In the example below, output 2 is being disconnected from input 3:

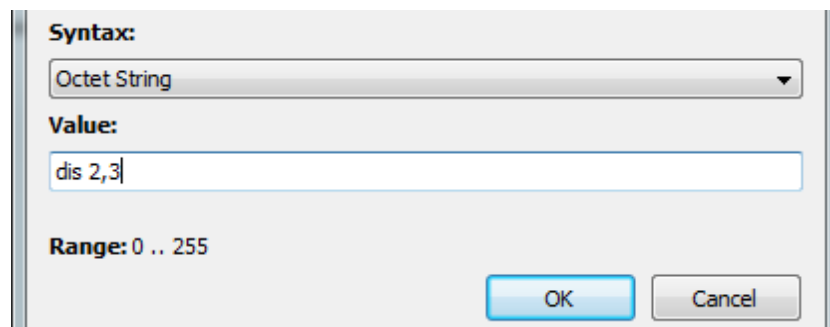

Syntax:
Octet String

Value:
dis 2,3

Range: 0 .. 255

OK Cancel

8.5.4.2. connectionTable

The optional connectionTable object may be used to query the status of the switching systems crosspoint configuration by right clicking on the object and selecting Table View,

The Query Results window displays a table where:

Output Index: Lists all output numbers

Pole0: Lists the inputs that are connected to the corresponding outputs as seen by pole0. See Section 6.2.4 for more details. A zero indicates that the output is not connected to any input. If the system has additional poles, there will be additional "pole" columns.

Module1: Lists the inputs that are connected to the corresponding outputs on module 1. If the system has additional modules, there will be additional "module" columns.

In the example below, input 1 is connected to output 2; input 3 is connected to output 5, etc.

Query Results

-----SNMP query started-----
Collecting table objects, please wait ...

Instance	outputIndex	pole0	module1
1	1	0	0
2	2	1	0
3	3	0	0
4	4	0	0
5	5	3	0
6	6	4	0
7	7	0	0
8	8	0	0

**THIS PAGE WAS
INTENTIONALLY LEFT
BLANK**

9. Web Interface

The C3-001 includes a web GUI interface for viewing and changing settings, status, system health, and crosspoint configurations. The web GUI is only available over the Ethernet interface and is compatible with most common web browsers such as Microsoft's Internet Explorer. Note that most of these settings are also available via the system front panel. See Section 2 for more details.

This manual section describes each page of the web GUI and its functionality. A summary of available web pages are below:

- System Information
- LAN Configuration
- SNMP Configuration
- System Settings
- Switch State
- Custom Labels
- Event Log
- Module Information
- Relay Cycle Log
- Diagnostic Information
- Event Scheduler
- Classing
- Firmware Update

To access the GUI, make sure the system is plugged into the LAN via a CAT 5 Ethernet cable and enter the system IP address into a compatible web browser.

NOTE: If the system is not on a LAN, You may also connect directly to the system with a PC by using a crossover cable.

9.1. System Information

The System information page contains general information about the system. It is read only and available to all users. Access to this page does not require the user to login to the GUI.



Information

USWI Switch

Information	Firmware Model	C3REV101
LAN Configuration	Rev Code	1903131307
SNMP Configuration	Manufacturer	Universal Switching
Settings	CPU Serial Number	C3-32840
Switch State	Manufacturer's Description	USWI Switch
Custom Labels	User's Description	USWI Switch
Event Log	LXI Extended Features	None
Module Information	LXI Version	1.4 LXI Device Specification 2011
Diagnostic	Host Name	us_C3REV101.local
Event Scheduler	MAC Address	00:0D:A6:00:80:48
Class Assignment	IP Address	192.168.30.103
Firmware Maintenance	Instrument Address String	TCPIP::192.168.30.103::7145::SOCKET
Administrator Account	Network ID	0
UniversalSwitching.com	TCP/IP Ports	7145 7147 7149 7151 7153 <small>These links can launch your terminal application and open a session to the switch. Not all browsers support this and some browser setup may be required. The default for the terminal application will probably not enable local echo and automatic linefeeds (ctrl-J). A sample command to type in "blindly" when the session is opened: *DN*(ctrl+J)</small>
Support Center	Uptime	0 Days, 0 Hours, 1 Minutes
	Front Panel ID	Off <input type="checkbox"/> ID

All subsequent menus require Admin access and the user will be prompted to login. The default user name is *admin*. The default password is *secret*.

9.2. LAN Configuration

The LAN configuration page provides read / write access to all available network settings. Contact your network administrator for appropriate settings.

To program static IP settings, you must first un-check the DHCP enabled check box. Settings are not updated on the system until the "Update" button is selected at the bottom of the page.



LAN Configuration

USWI Switch

Information	Bonjour/mDNS Hostname	<input type="text" value="us_C3REV101"/> .local
LAN Configuration	Manufacturer's Description	USWI Switch
SNMP Configuration	User's Description	<input type="text" value="USWI Switch"/>
Settings	Use Port 80(HTTP)	<input type="checkbox"/> Enable
Switch State	DHCP/LLA	<input checked="" type="checkbox"/> Enable
Custom Labels	IP Address	<input type="text" value="192.168.30.103"/>
Event Log	Subnet Mask	<input type="text" value="255.255.255.0"/>
Module Information	Default Gateway	<input type="text" value="192.168.30.1"/>
Diagnostic	DNS Server	<input type="text" value="168.95.1.1"/>
Event Scheduler	Network ID	<input type="text" value="0"/>
Class Assignment	TCP/IP Port	Port List: :7145 :7147 :7149 :7151 :7153 <small>*Maximum of 10 ports with a range of 1 to 32767</small>
Firmware Maintenance		Add Port: <input type="text" value="0"/>
Administrator Account		Delete Port: <input type="text" value="0"/>
UniversalSwitching.com		
Support Center		

9.3. SNMP Configuration

The SNMP Configuration page provides read / write access for the various SNMP settings. Version 3 provides secure access to Universal Switching Corporation products by authenticating and encrypting data packets over the network.



SNMP Configuration USWI Switch

Information LAN Configuration SNMP Configuration Settings Switch State Custom Labels Event Log Module Information Diagnostic Event Scheduler Class Assignment Firmware Maintenance Administrator Account UniversalSwitching.com Support Center	<p>SNMPv1/SNMPv2c</p> <table border="1"> <tr> <td>SNMPv1/2c Agent</td> <td><input type="checkbox"/> Enable</td> </tr> <tr> <td>Read Community</td> <td><input type="text" value="public"/></td> </tr> <tr> <td>Write Community</td> <td><input type="text" value="public"/></td> </tr> </table> <p>SNMPv3</p> <table border="1"> <tr> <td>Group Select</td> <td><input type="text" value="Group 1"/> <input checked="" type="checkbox"/> Active</td> </tr> <tr> <td>Group Name</td> <td><input type="text" value="admin-SHA"/></td> </tr> <tr> <td>Context Name</td> <td><input type="text" value="admin"/></td> </tr> <tr> <td>Context ID</td> <td><input type="text" value="0x000a0ea01c0a01e67"/> <small>Set to 0 to revert to default ContextID, value is in Hexadecimal.</small></td> </tr> <tr> <td>Authentication Protocol</td> <td><input type="text" value="SHA"/></td> </tr> <tr> <td>Authentication Passphrase</td> <td><input type="text" value="....."/></td> </tr> <tr> <td>Auth Passphrase Confirm</td> <td><input type="text" value="....."/></td> </tr> <tr> <td>Privacy Protocol</td> <td><input type="text" value="AES-128"/></td> </tr> <tr> <td>Privacy Passphrase</td> <td><input type="text" value="....."/></td> </tr> <tr> <td>Priv Passphrase Confirm</td> <td><input type="text" value="....."/></td> </tr> <tr> <td>Group Membership</td> <td><input type="radio"/> Read Only <input checked="" type="radio"/> Read/Write</td> </tr> </table> <p>SNMP Traps</p> <table border="1"> <tr> <td>Trap Type</td> <td><input type="radio"/> None <input type="radio"/> SNMPv1/2c <input checked="" type="radio"/> SNMPv3</td> </tr> <tr> <td>Primary Trap Host IP</td> <td><input type="text" value="192.168.30.96"/></td> </tr> <tr> <td>Secondary Trap Host IP</td> <td><input type="text" value="0.0.0.0"/></td> </tr> <tr> <td>SNMPv3 Trap Host</td> <td><input type="text" value="Group 1"/></td> </tr> </table> <p><input type="button" value="Update"/></p>	SNMPv1/2c Agent	<input type="checkbox"/> Enable	Read Community	<input type="text" value="public"/>	Write Community	<input type="text" value="public"/>	Group Select	<input type="text" value="Group 1"/> <input checked="" type="checkbox"/> Active	Group Name	<input type="text" value="admin-SHA"/>	Context Name	<input type="text" value="admin"/>	Context ID	<input type="text" value="0x000a0ea01c0a01e67"/> <small>Set to 0 to revert to default ContextID, value is in Hexadecimal.</small>	Authentication Protocol	<input type="text" value="SHA"/>	Authentication Passphrase	<input type="text" value="....."/>	Auth Passphrase Confirm	<input type="text" value="....."/>	Privacy Protocol	<input type="text" value="AES-128"/>	Privacy Passphrase	<input type="text" value="....."/>	Priv Passphrase Confirm	<input type="text" value="....."/>	Group Membership	<input type="radio"/> Read Only <input checked="" type="radio"/> Read/Write	Trap Type	<input type="radio"/> None <input type="radio"/> SNMPv1/2c <input checked="" type="radio"/> SNMPv3	Primary Trap Host IP	<input type="text" value="192.168.30.96"/>	Secondary Trap Host IP	<input type="text" value="0.0.0.0"/>	SNMPv3 Trap Host	<input type="text" value="Group 1"/>
SNMPv1/2c Agent	<input type="checkbox"/> Enable																																				
Read Community	<input type="text" value="public"/>																																				
Write Community	<input type="text" value="public"/>																																				
Group Select	<input type="text" value="Group 1"/> <input checked="" type="checkbox"/> Active																																				
Group Name	<input type="text" value="admin-SHA"/>																																				
Context Name	<input type="text" value="admin"/>																																				
Context ID	<input type="text" value="0x000a0ea01c0a01e67"/> <small>Set to 0 to revert to default ContextID, value is in Hexadecimal.</small>																																				
Authentication Protocol	<input type="text" value="SHA"/>																																				
Authentication Passphrase	<input type="text" value="....."/>																																				
Auth Passphrase Confirm	<input type="text" value="....."/>																																				
Privacy Protocol	<input type="text" value="AES-128"/>																																				
Privacy Passphrase	<input type="text" value="....."/>																																				
Priv Passphrase Confirm	<input type="text" value="....."/>																																				
Group Membership	<input type="radio"/> Read Only <input checked="" type="radio"/> Read/Write																																				
Trap Type	<input type="radio"/> None <input type="radio"/> SNMPv1/2c <input checked="" type="radio"/> SNMPv3																																				
Primary Trap Host IP	<input type="text" value="192.168.30.96"/>																																				
Secondary Trap Host IP	<input type="text" value="0.0.0.0"/>																																				
SNMPv3 Trap Host	<input type="text" value="Group 1"/>																																				

9.4. System Settings

The system settings page provides read / write access to other available settings:



System Settings
64*64 Matrix

- [System Information](#)
- [LAN Configuration](#)
- [System Settings](#)
- [Switch State](#)
- [Custom Labels](#)
- [Event Log](#)
- [Diagnostic](#)
- [Event Scheduler](#)
- [Class Assignment](#)
- [Firmware Maintenance](#)
- [Administrator Account](#)
- [UniversalSwitching.com](#)
- [Support Center](#)

System Clock	Month: <input type="text" value="9"/> / Day: <input type="text" value="26"/> / Year: <input type="text" value="16"/> Hours: <input type="text" value="11"/> : Minutes: <input type="text" value="1"/> : Seconds: <input type="text" value="48"/>
	<input type="checkbox"/> Use NTP Time Sync NTP Server: <input type="text" value="us.pool.ntp.org"/> Time Zone: <input type="text" value="UTC+0:00"/>
Serial Port	Serial Mode: <input type="text" value="RS232"/> RS-485 Address: <input type="text" value="0"/> Baud Rate: <input type="text" value="9600"/> Data Bit: 8 Parity: <input type="text" value="None"/> Stop: <input type="text" value="1"/> Flow Control: <input type="text" value="Off"/>
SD Card Mode	<input type="checkbox"/> SD Only
Auto-Interlock	<input checked="" type="checkbox"/> Enable
Power-On Restore	<input checked="" type="checkbox"/> Enable
Beep On Error	<input checked="" type="checkbox"/> Enable

9.5. Switch State

The Switch State page is a dynamic page that allows the operator to view and change existing crosspoint connections as well as save or recall switch configurations from memory. You may also enable the Intra-Matrix (See Section 2.14.6.3. for details). Actions are not applied to the system until the “Send Update” button is selected.

Use the refresh button to update the table with any crosspoint changes that have been made from a remote interface or front panel.

Reference the following sections in this manual for the following functions:

- Poles: Section 6.2.4
- Ganged Mode: 6.2.3
- Auto-Interlock: 2.14.6.1.
- Save / Recall Configurations: 2.11
- Intra Matrix & MOD: 2.14.6.3.

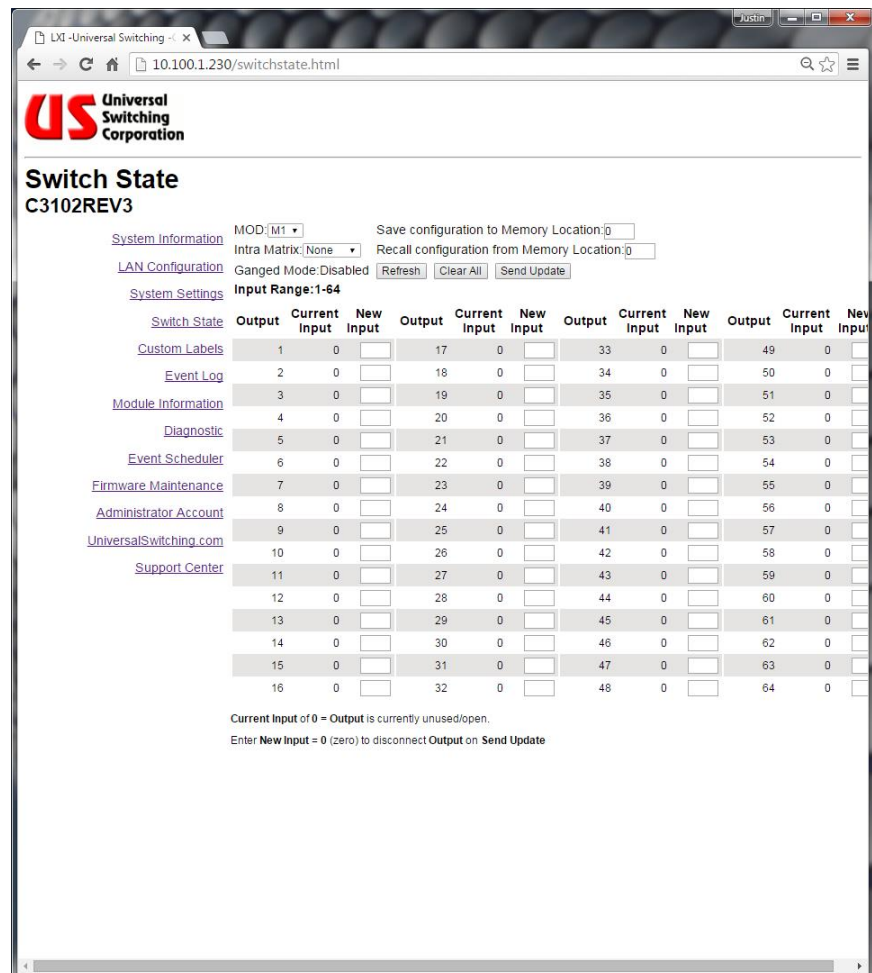

Switch State
C3102REV3

System Information: MOD: M1, Intra Matrix: None, Save configuration to Memory Location: 0, Recall configuration from Memory Location: 0

LAN Configuration: Ganged Mode: Disabled, Refresh, Clear All, Send Update

System Settings: Input Range: 1-64

Output	Current Input	New Input	Output	Current Input	New Input	Output	Current Input	New Input	Output	Current Input	New Input
1	0	<input type="text"/>	17	0	<input type="text"/>	33	0	<input type="text"/>	49	0	<input type="text"/>
2	0	<input type="text"/>	18	0	<input type="text"/>	34	0	<input type="text"/>	50	0	<input type="text"/>
3	0	<input type="text"/>	19	0	<input type="text"/>	35	0	<input type="text"/>	51	0	<input type="text"/>
4	0	<input type="text"/>	20	0	<input type="text"/>	36	0	<input type="text"/>	52	0	<input type="text"/>
5	0	<input type="text"/>	21	0	<input type="text"/>	37	0	<input type="text"/>	53	0	<input type="text"/>
6	0	<input type="text"/>	22	0	<input type="text"/>	38	0	<input type="text"/>	54	0	<input type="text"/>
7	0	<input type="text"/>	23	0	<input type="text"/>	39	0	<input type="text"/>	55	0	<input type="text"/>
8	0	<input type="text"/>	24	0	<input type="text"/>	40	0	<input type="text"/>	56	0	<input type="text"/>
9	0	<input type="text"/>	25	0	<input type="text"/>	41	0	<input type="text"/>	57	0	<input type="text"/>
10	0	<input type="text"/>	26	0	<input type="text"/>	42	0	<input type="text"/>	58	0	<input type="text"/>
11	0	<input type="text"/>	27	0	<input type="text"/>	43	0	<input type="text"/>	59	0	<input type="text"/>
12	0	<input type="text"/>	28	0	<input type="text"/>	44	0	<input type="text"/>	60	0	<input type="text"/>
13	0	<input type="text"/>	29	0	<input type="text"/>	45	0	<input type="text"/>	61	0	<input type="text"/>
14	0	<input type="text"/>	30	0	<input type="text"/>	46	0	<input type="text"/>	62	0	<input type="text"/>
15	0	<input type="text"/>	31	0	<input type="text"/>	47	0	<input type="text"/>	63	0	<input type="text"/>
16	0	<input type="text"/>	32	0	<input type="text"/>	48	0	<input type="text"/>	64	0	<input type="text"/>

Current Input of 0 = Output is currently unused/open.
Enter New Input = 0 (zero) to disconnect Output on Send Update

The screenshot below shows the same 64x64 matrix but with the Series Intra Matrix enabled for synchronous clock / data applications. The 64x64 matrix is now treated as a 32x32 matrix where input 1 on the web GUI translates to inputs 1 and 2 on the hardware.

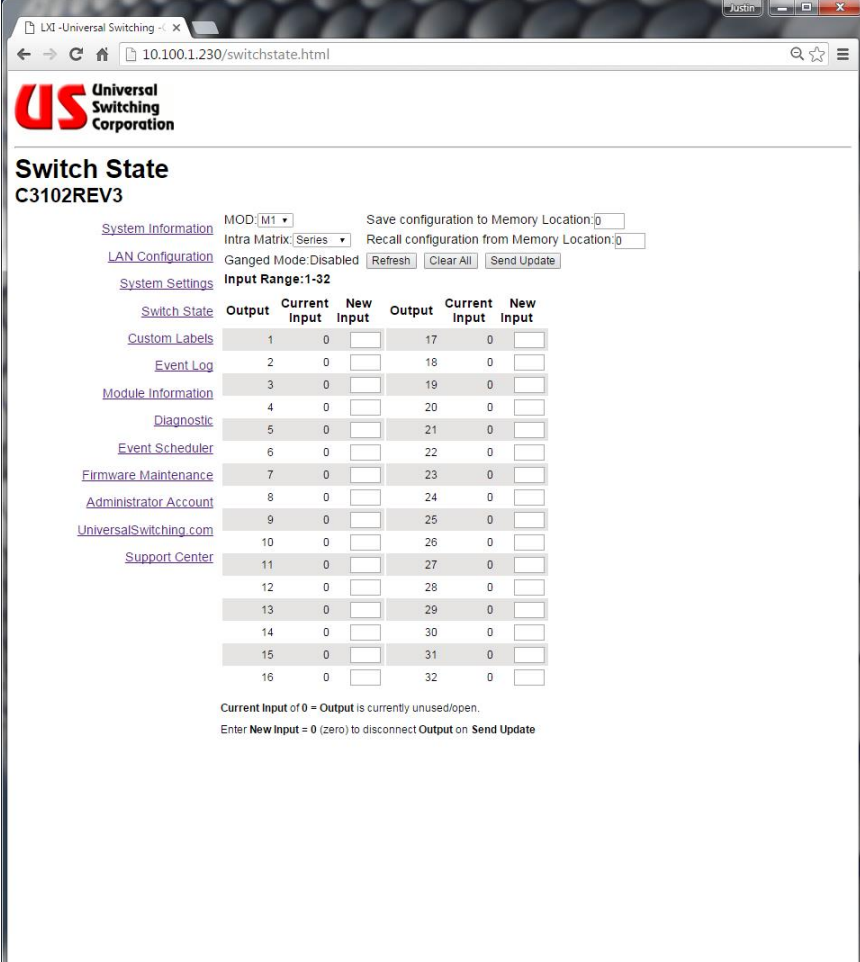

Switch State
C3102REV3

[System Information](#) MOD: IM1 Save configuration to Memory Location:
[LAN Configuration](#) Intra Matrix: Series Recall configuration from Memory Location:
[System Settings](#) Ganged Mode: Disabled
[Switch State](#) **Input Range: 1-32**

	Output	Current Input	New Input	Output	Current Input	New Input
1	0	<input type="text" value="0"/>	<input type="text" value="0"/>	17	0	<input type="text" value="0"/>
2	0	<input type="text" value="0"/>	<input type="text" value="0"/>	18	0	<input type="text" value="0"/>
3	0	<input type="text" value="0"/>	<input type="text" value="0"/>	19	0	<input type="text" value="0"/>
4	0	<input type="text" value="0"/>	<input type="text" value="0"/>	20	0	<input type="text" value="0"/>
5	0	<input type="text" value="0"/>	<input type="text" value="0"/>	21	0	<input type="text" value="0"/>
6	0	<input type="text" value="0"/>	<input type="text" value="0"/>	22	0	<input type="text" value="0"/>
7	0	<input type="text" value="0"/>	<input type="text" value="0"/>	23	0	<input type="text" value="0"/>
8	0	<input type="text" value="0"/>	<input type="text" value="0"/>	24	0	<input type="text" value="0"/>
9	0	<input type="text" value="0"/>	<input type="text" value="0"/>	25	0	<input type="text" value="0"/>
10	0	<input type="text" value="0"/>	<input type="text" value="0"/>	26	0	<input type="text" value="0"/>
11	0	<input type="text" value="0"/>	<input type="text" value="0"/>	27	0	<input type="text" value="0"/>
12	0	<input type="text" value="0"/>	<input type="text" value="0"/>	28	0	<input type="text" value="0"/>
13	0	<input type="text" value="0"/>	<input type="text" value="0"/>	29	0	<input type="text" value="0"/>
14	0	<input type="text" value="0"/>	<input type="text" value="0"/>	30	0	<input type="text" value="0"/>
15	0	<input type="text" value="0"/>	<input type="text" value="0"/>	31	0	<input type="text" value="0"/>
16	0	<input type="text" value="0"/>	<input type="text" value="0"/>	32	0	<input type="text" value="0"/>

Current Input of 0 = Output is currently unused/open.
 Enter New Input = 0 (zero) to disconnect Output on

The screenshot below shows the same 64x64 matrix but with the Parallel Intra Matrix enabled for synchronous clock / data applications. The 64x64 matrix is now treated as a 32x32 matrix where input 1 on the web GUI translates to inputs 1 and 33 on the hardware.

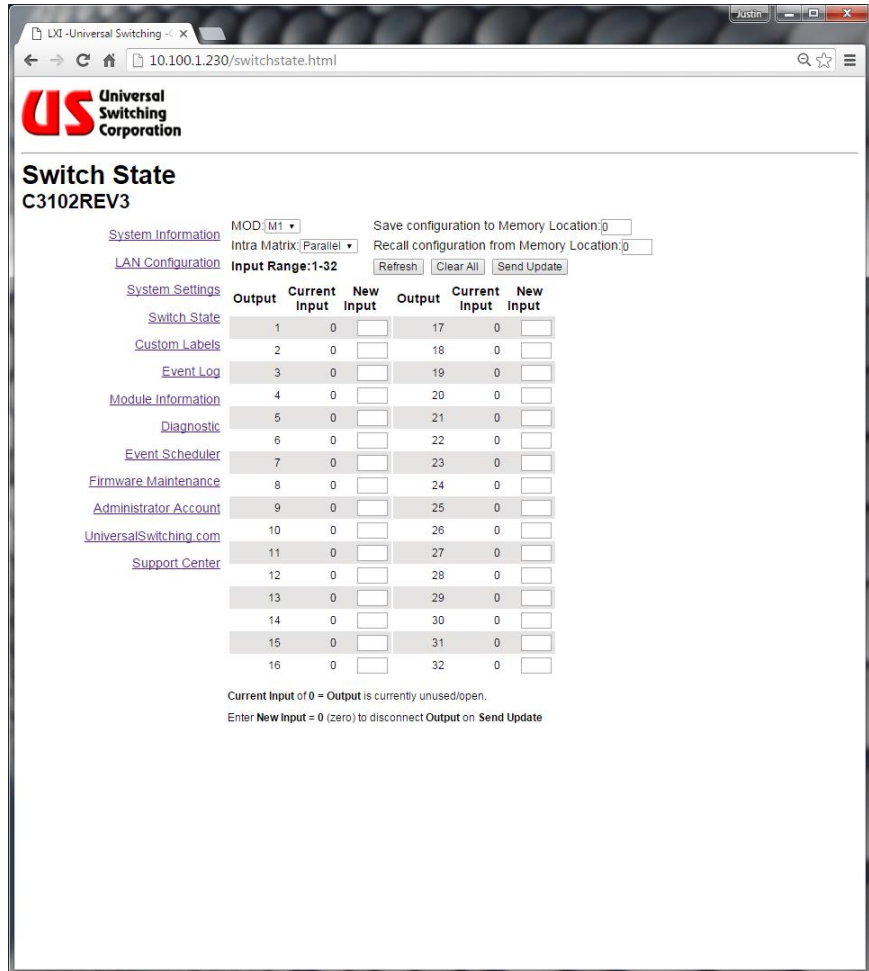

Switch State
C3102REV3

[System Information](#) MOD: MT Save configuration to Memory Location: 0
[LAN Configuration](#) Intra Matrix: Parallel Recall configuration from Memory Location: 0

[System Settings](#)

	Output	Current Input	New Input	Output	Current Input	New Input
Switch State	1	0	<input type="text"/>	17	0	<input type="text"/>
Custom Labels	2	0	<input type="text"/>	18	0	<input type="text"/>
Event Log	3	0	<input type="text"/>	19	0	<input type="text"/>
Module Information	4	0	<input type="text"/>	20	0	<input type="text"/>
Diagnostic	5	0	<input type="text"/>	21	0	<input type="text"/>
Event Scheduler	6	0	<input type="text"/>	22	0	<input type="text"/>
Firmware Maintenance	7	0	<input type="text"/>	23	0	<input type="text"/>
Administrator Account	8	0	<input type="text"/>	24	0	<input type="text"/>
UniversalSwitching.com	9	0	<input type="text"/>	25	0	<input type="text"/>
Support Center	10	0	<input type="text"/>	26	0	<input type="text"/>
	11	0	<input type="text"/>	27	0	<input type="text"/>
	12	0	<input type="text"/>	28	0	<input type="text"/>
	13	0	<input type="text"/>	29	0	<input type="text"/>
	14	0	<input type="text"/>	30	0	<input type="text"/>
	15	0	<input type="text"/>	31	0	<input type="text"/>
	16	0	<input type="text"/>	32	0	<input type="text"/>

Current Input of 0 = Output is currently unused/open.
 Enter New Input = 0 (zero) to disconnect Output on Send Update

9.6. Custom Labels

The Custom Labels page provides an alternative method to setting custom labels to the inputs, outputs (See Sections 2.12.2, 5.3.31) and memory configurations (See Sections 2.11, 0).

Select the bubble for either output, input, or SAV/RCL Label. Enter the index number and the new label. When finished, press the update button.

Note that there is a 10 character maximum and restricted characters include the quotation mark, comma, and semicolon.

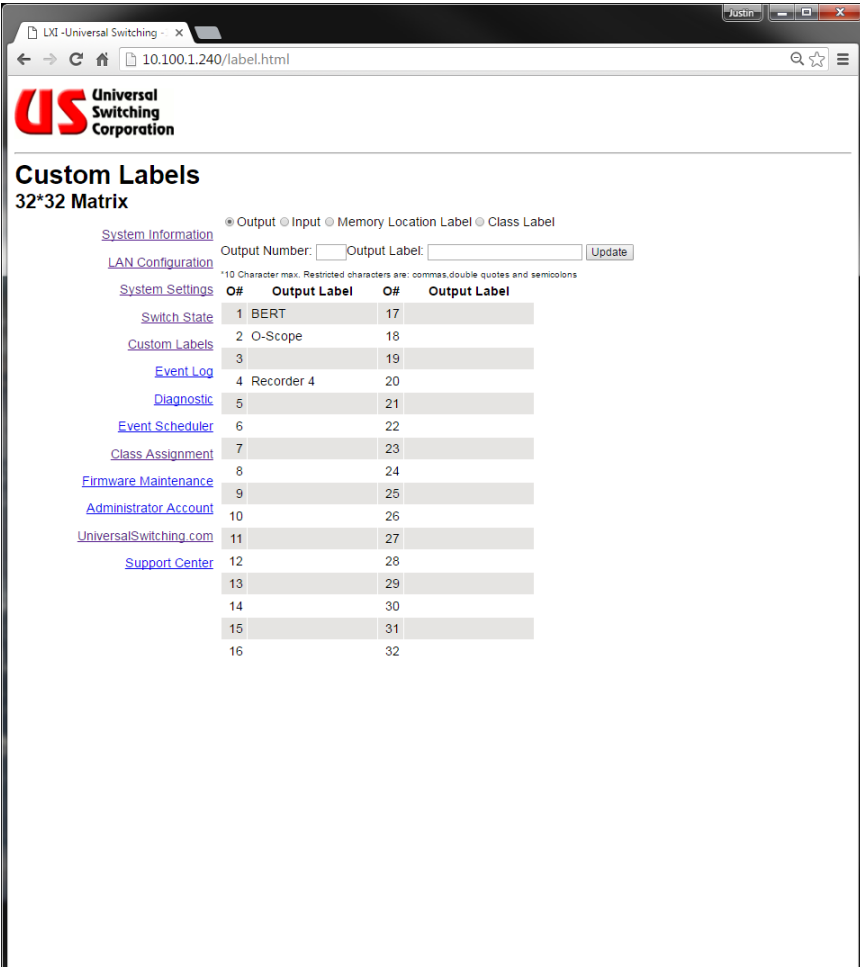

Custom Labels
32*32 Matrix

Output
 Input
 Memory Location Label
 Class Label

Output Number: Output Label:

*10 Character max. Restricted characters are: commas, double quotes and semicolons

O#	Output Label	O#	Output Label
1	BERT	17	
2	O-Scope	18	
3		19	
4	Recorder 4	20	
5		21	
6		22	
7		23	
8		24	
9		25	
10		26	
11		27	
12		28	
13		29	
14		30	
15		31	
16		32	

9.7. Event Log

The event log tracks all activity from any of the remote interfaces, web GUI, and front panel touchscreen display. Events are timestamped and show the command or query and results. You have the option to show all events or just errors only. You can also export the log file to a .txt file on your computer. See Sections 2.14.1.1. and 5.3.35 for more details.



The screenshot displays the Event Log for device C3102REV3. The interface includes a navigation menu on the left with links for System Information, LAN Configuration, System Settings, Switch State, Custom Labels, Event Log, Module Information, Diagnostic, Event Scheduler, Firmware Maintenance, Administrator Account, UniversalSwitching.com, and Support Center. The main content area shows a table of log entries with columns for timestamp, command, and result. The table is currently set to 'Show All' events.

Timestamp	Command	Result
2015-12-15 15:18	LOU 4, 0, 0	_OK
2015-12-15 15:18	LOU 2, 0, 0	_OK
2015-12-15 15:18	LOU 1, 0, 0	_OK
2015-12-15 15:17	SET 88, 2	_OK
2015-12-15 15:17	SET 88, 1	_OK
2015-12-15 14:38	SET 61, 131	_OK
2015-12-15 14:38	SET 20, 0	_OK
2015-12-15 14:38	SAV 231	_OK
2015-12-15 14:38	SAV 231	_OK

9.8. Module Information

The module information page allows the user to identify the firmware and revision code that is installed in each of the system modules. System modules include the switch matrix modules and power supply modules.

Additionally, this page will allow the user to update the firmware that is installed on each module should there be a requirement to do so. The factory will provide the appropriate firmware files if necessary.

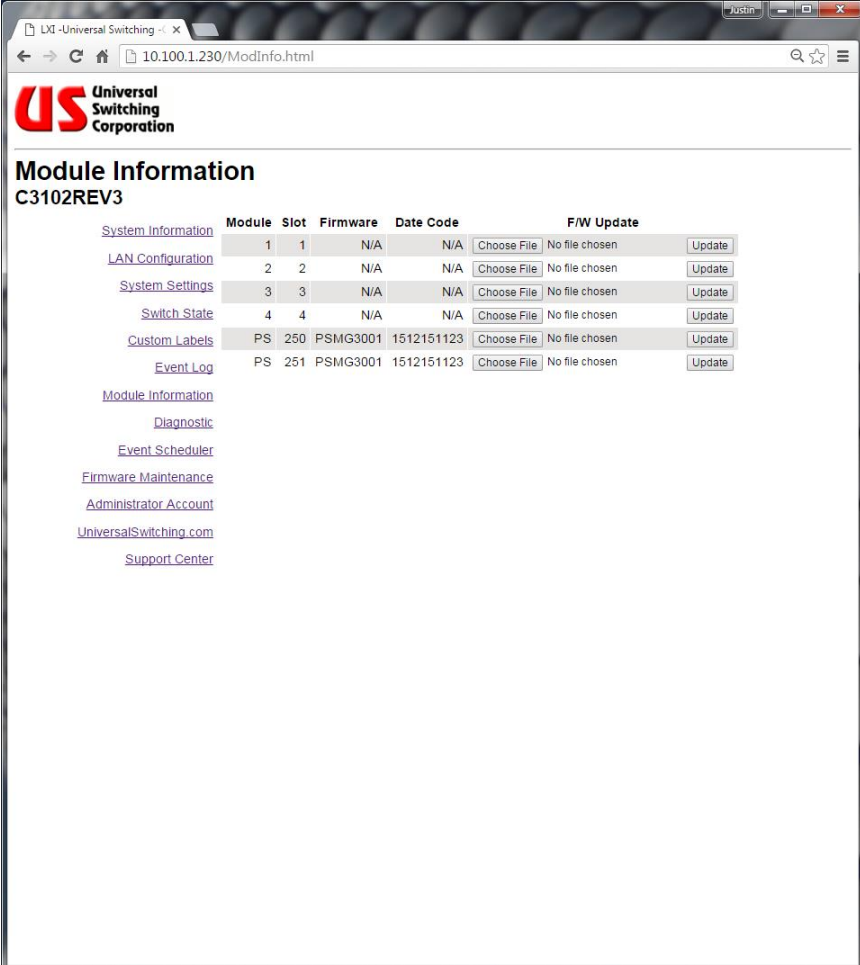

Module Information
C3102REV3

	Module	Slot	Firmware	Date Code	F/W Update	
System Information	1	1	N/A	N/A	<input type="button" value="Choose File"/>	No file chosen <input type="button" value="Update"/>
LAN Configuration	2	2	N/A	N/A	<input type="button" value="Choose File"/>	No file chosen <input type="button" value="Update"/>
System Settings	3	3	N/A	N/A	<input type="button" value="Choose File"/>	No file chosen <input type="button" value="Update"/>
Switch State	4	4	N/A	N/A	<input type="button" value="Choose File"/>	No file chosen <input type="button" value="Update"/>
Custom Labels	PS	250	PSMG3001	1512151123	<input type="button" value="Choose File"/>	No file chosen <input type="button" value="Update"/>
Event Log	PS	251	PSMG3001	1512151123	<input type="button" value="Choose File"/>	No file chosen <input type="button" value="Update"/>

[Module Information](#)
[Diagnostic](#)
[Event Scheduler](#)
[Firmware Maintenance](#)
[Administrator Account](#)
[UniversalSwitching.com](#)
[Support Center](#)

9.9. Relay Cycle Log

In systems that utilize electro-mechanical switches with a finite life span or cycle count, the Relay Cycle Log will track the usage of each relay inside the module. This information can then be used to identify relays that are approaching the end of their life span and should be considered for replacement. As the life span of relays may vary depending on the model, consult the Operations Manual for your specific system to determine the life span specification of the relays.

If a new relay has been installed, the cycle count should be reset. Enter the relay number, the admin password and press the Reset Relay button.

The log is also available via the front panel. See Section 2.14.1.6. for more details.

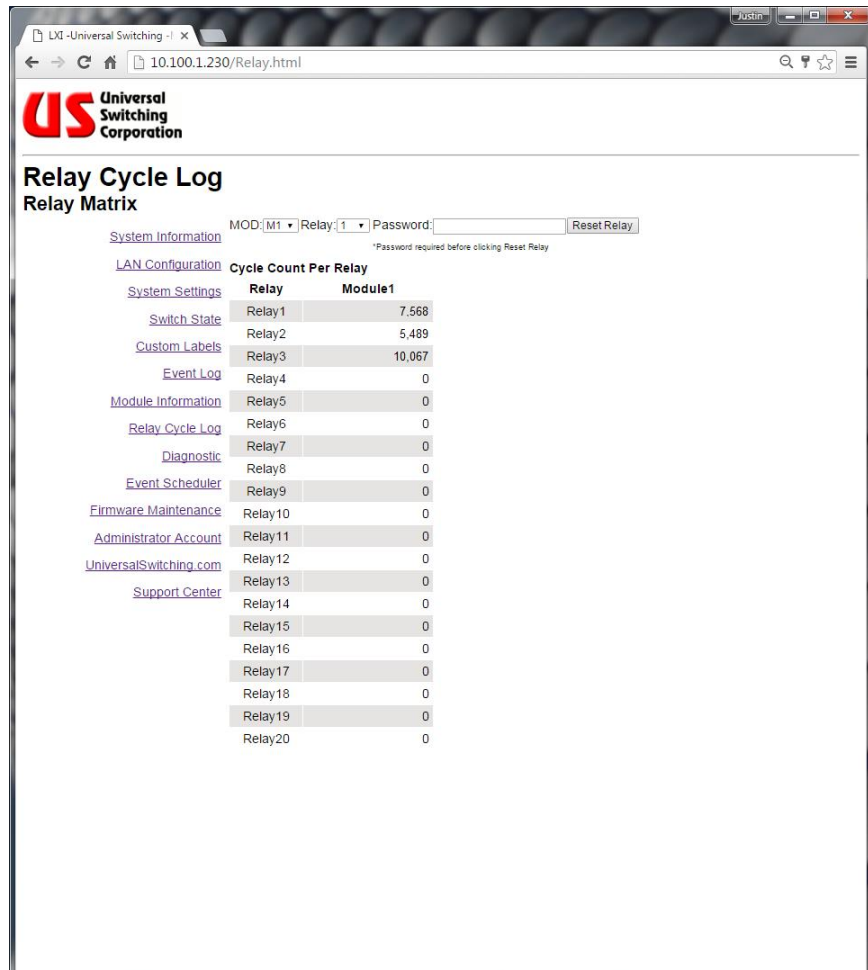

MOD: [M1] Relay: [1] Password:

*Password required before clicking Reset Relay

Relay	Module1
Relay1	7,568
Relay2	5,489
Relay3	10,067
Relay4	0
Relay5	0
Relay6	0
Relay7	0
Relay8	0
Relay9	0
Relay10	0
Relay11	0
Relay12	0
Relay13	0
Relay14	0
Relay15	0
Relay16	0
Relay17	0
Relay18	0
Relay19	0
Relay20	0

9.10. Diagnostic

The Diagnostic page provides system health and status. Any reported failures or faults will be displayed in the System Health field. A self test may also be initiated by pressing the TST button.

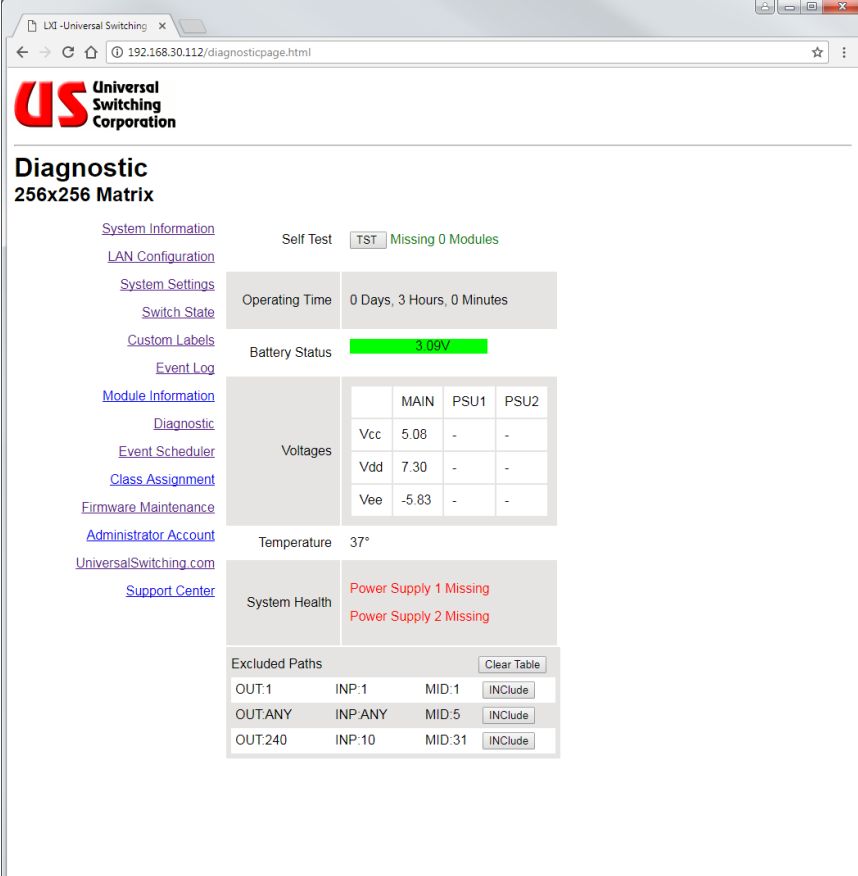

The screenshot shows the 'Diagnostic' page for a '256x256 Matrix'. The page includes a navigation menu on the left with links for System Information, LAN Configuration, System Settings, Switch State, Custom Labels, Event Log, Module Information, Diagnostic, Event Scheduler, Class Assignment, Firmware Maintenance, Administrator Account, UniversalSwitching.com, and Support Center.

Key diagnostic information displayed includes:

- Self Test:** TST button, Missing 0 Modules
- Operating Time:** 0 Days, 3 Hours, 0 Minutes
- Battery Status:** 3.09V (indicated by a green bar)
- Voltages:**

	MAIN	PSU1	PSU2
Vcc	5.08	-	-
Vdd	7.30	-	-
Vee	-5.83	-	-
- Temperature:** 37°
- System Health:** Power Supply 1 Missing, Power Supply 2 Missing
- Excluded Paths:**

OUT	INP	MID	Include
OUT:1	INP:1	MID:1	INCLUDE
OUT:ANY	INP:ANY	MID:5	INCLUDE
OUT:240	INP:10	MID:31	INCLUDE

9.11. Event Scheduler

The event scheduler is discussed in detail in Section 2.14.3. You may set the unit to recall a stored crosspoint configuration on 30 minute intervals throughout the day. You may also choose to repeat the event daily or not.

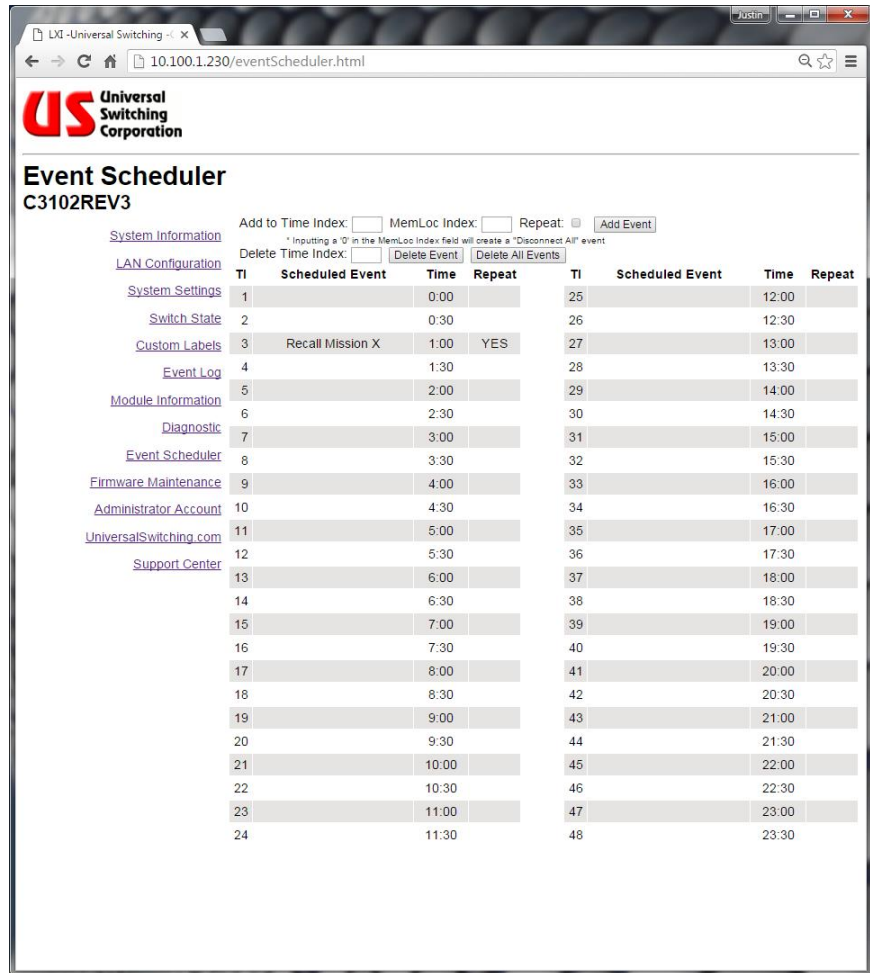

Event Scheduler
C3102REV3

Add to Time Index: MemLoc Index: Repeat: [Add Event](#)

* Inputting a '0' in the MemLoc Index field will create a "Disconnect All" event

Delete Time Index: [Delete Event](#) [Delete All Events](#)

TI	Scheduled Event	Time	Repeat	TI	Scheduled Event	Time	Repeat
1		0:00		25		12:00	
2		0:30		26		12:30	
3	Recall Mission X	1:00	YES	27		13:00	
4		1:30		28		13:30	
5		2:00		29		14:00	
6		2:30		30		14:30	
7		3:00		31		15:00	
8		3:30		32		15:30	
9		4:00		33		16:00	
10		4:30		34		16:30	
11		5:00		35		17:00	
12		5:30		36		17:30	
13		6:00		37		18:00	
14		6:30		38		18:30	
15		7:00		39		19:00	
16		7:30		40		19:30	
17		8:00		41		20:00	
18		8:30		42		20:30	
19		9:00		43		21:00	
20		9:30		44		21:30	
21		10:00		45		22:00	
22		10:30		46		22:30	
23		11:00		47		23:00	
24		11:30		48		23:30	

9.12. Classing

Classing is a feature that allows the user to assign inputs and outputs to one or many classes where only similarly classed I/O's can be connected. See Section **Error! Reference source not found.** for more details.

First select either **input** or **output**. Then enter the input or output **number** that you want to assign, the **class index** number, then press **Add Class**. To remove a class, enter the desired I/O number, class index that is currently assigned and press **Delete Class**.

The **Set Global** button can be used to quickly remove all class assignments from a given input or output (setting it back to default 0).

The **Set All Global** button can be used to quickly remove all class assignments from all inputs or outputs (setting them all back to default 0),

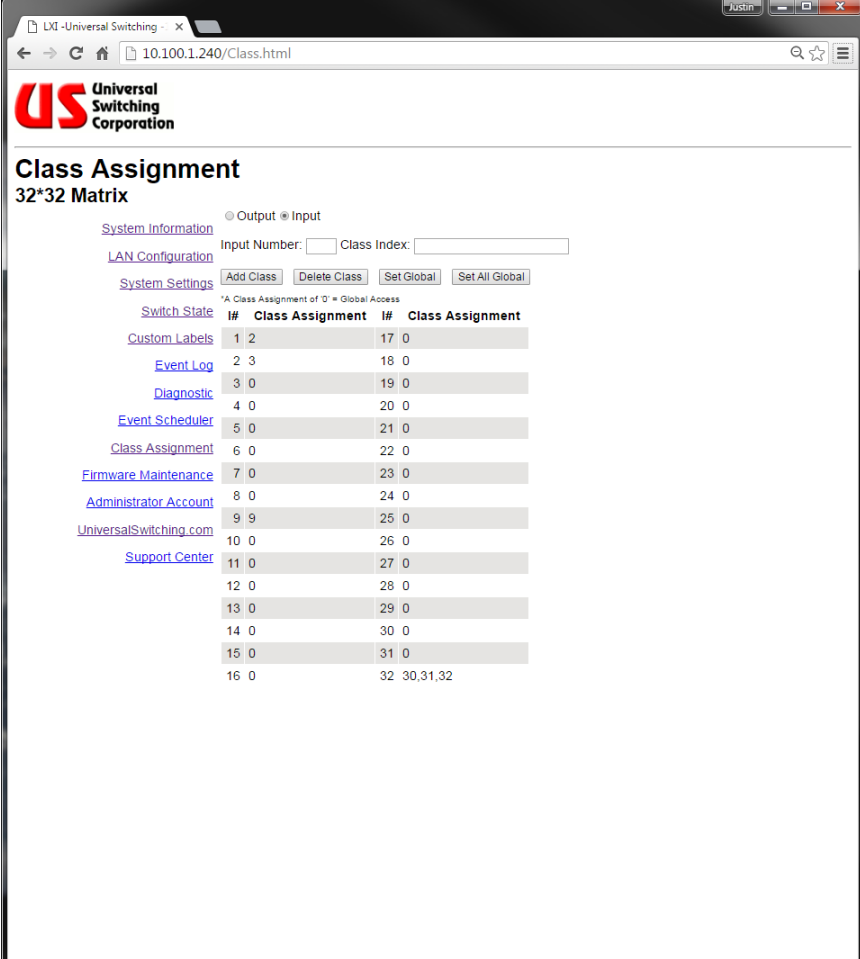

Class Assignment
32*32 Matrix

System Information Output Input
 LAN Configuration Input Number: Class Index:
 System Settings
 Switch State
 Custom Labels
 Event Log
 Diagnostic
 Event Scheduler
 Class Assignment
 Firmware Maintenance
 Administrator Account
 UniversalSwitching.com
 Support Center

#	Class Assignment	#	Class Assignment
1	2	17	0
2	3	18	0
3	0	19	0
4	0	20	0
5	0	21	0
6	0	22	0
7	0	23	0
8	0	24	0
9	9	25	0
10	0	26	0
11	0	27	0
12	0	28	0
13	0	29	0
14	0	30	0
15	0	31	0
16	0	32	30,31,32

*A Class Assignment of 0 = Global Access

9.13. Firmware Maintenance

The system's main CPU controller may require firmware updates from time to time to address bugs or customer requested feature changes. This page allows the user to upload the firmware file provided by the USWI support team directly to the system over Ethernet. No additional cables are required.

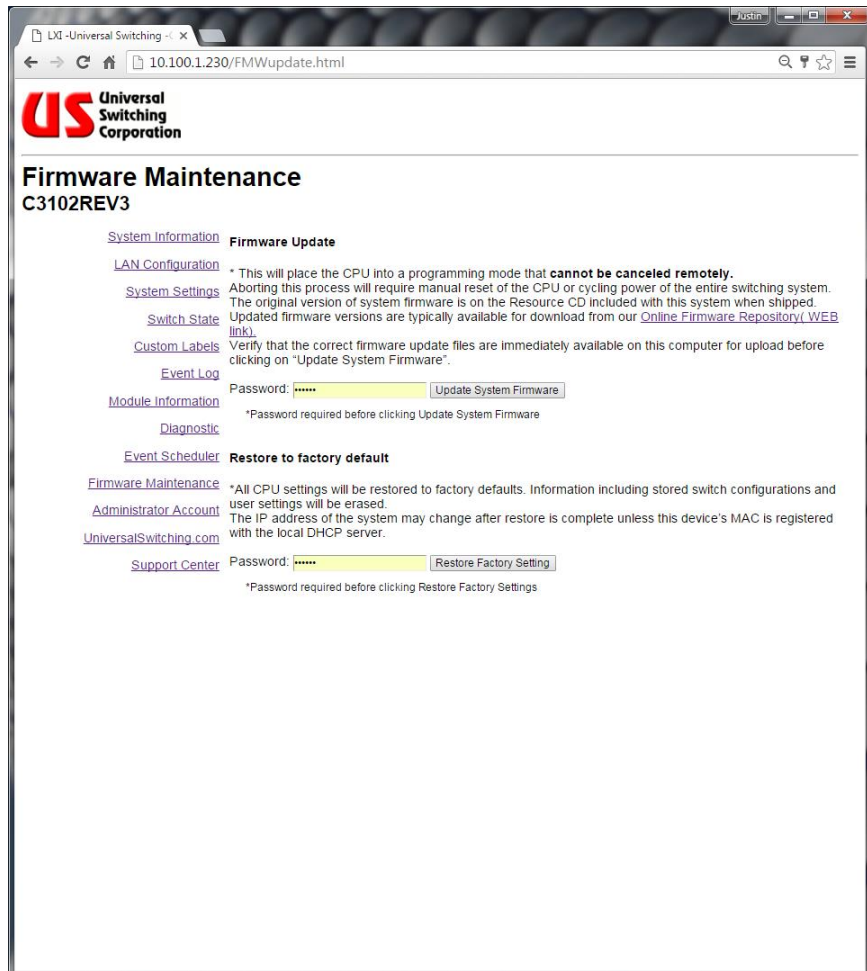

9.14. Administrator Account

This page allows the operator to change the default admin password to something more secure. The password cannot exceed 20 characters.

US Universal Switching Corporation

Administrator Account C3102REV3

[System Information](#) Old Password:

[LAN Configuration](#) New Password:

[System Settings](#) Confirm Password:

[Switch State](#) *Maximum password length is 20.

[Custom Labels](#)

[Event Log](#)

[Module Information](#)

[Diagnostic](#)

[Event Scheduler](#)

[Firmware Maintenance](#)

[Administrator Account](#)

[UniversalSwitching.com](#)

[Support Center](#)

9.15. Manufacturer Website

This link will launch www.USWI.com. If your PC is not connected to the internet, you may receive an error message.

9.16. Support Center

This page provides contact information for Universal Switching Corporation.

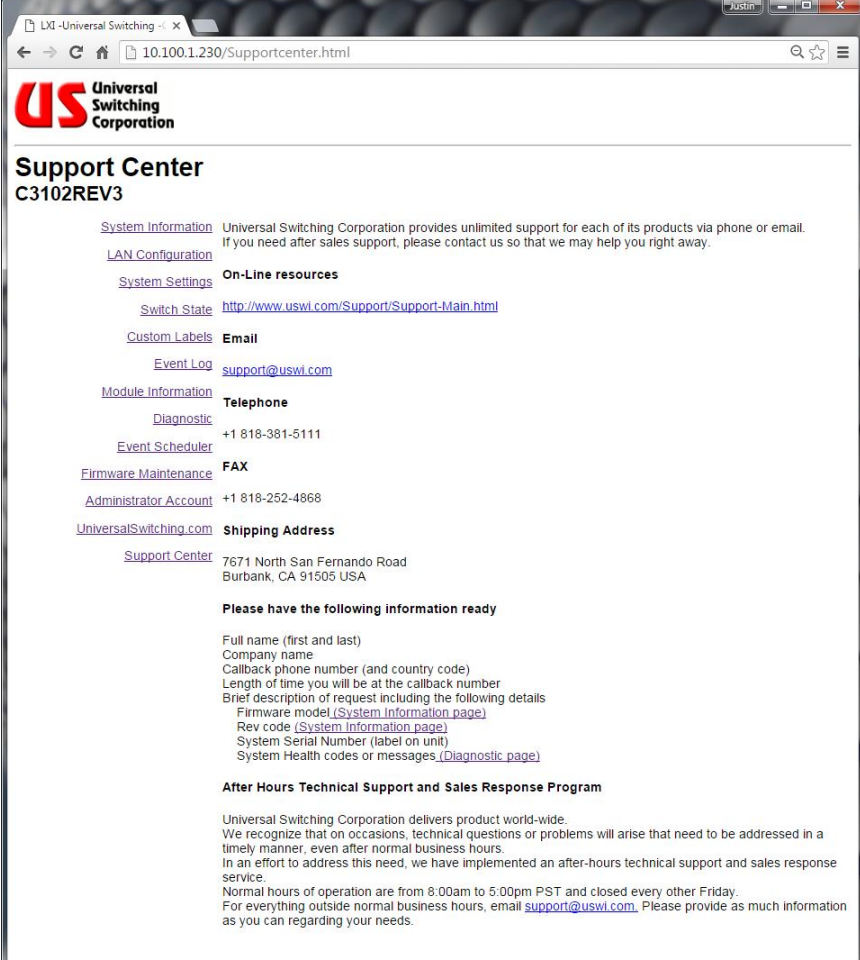

[System Information](#) Universal Switching Corporation provides unlimited support for each of its products via phone or email. If you need after sales support, please contact us so that we may help you right away.

[LAN Configuration](#)

[System Settings](#)

[Switch State](#) <http://www.uswi.com/Support/Support-Main.html>

[Custom Labels](#)

[Event Log](#) support@uswi.com

[Module Information](#)

[Diagnostic](#)

[Event Scheduler](#)

[Firmware Maintenance](#)

[Administrator Account](#)

[UniversalSwitching.com](#)

[Support Center](#)

On-Line resources

Email

Telephone

+1 818-381-5111

FAX

+1 818-252-4868

Shipping Address

7671 North San Fernando Road
 Burbank, CA 91505 USA

Please have the following information ready

Full name (first and last)
 Company name
 Callback phone number (and country code)
 Length of time you will be at the callback number
 Brief description of request including the following details
 Firmware model ([System Information page](#))
 Rev code ([System Information page](#))
 System Serial Number (label on unit)
 System Health codes or messages ([Diagnostic page](#))

After Hours Technical Support and Sales Response Program

Universal Switching Corporation delivers product world-wide. We recognize that on occasions, technical questions or problems will arise that need to be addressed in a timely manner, even after normal business hours. In an effort to address this need, we have implemented an after-hours technical support and sales response service. Normal hours of operation are from 8:00am to 5:00pm PST and closed every other Friday. For everything outside normal business hours, email support@uswi.com. Please provide as much information as you can regarding your needs.

10. microSD Card

The C3-001 may optionally use a microSD Card for memory retention. The SD card provides two basic functions as outlined below. Cards are typically not included with shipments but are available for purchase. Standard store bought cards may also be used:

- **Redundant Mode:** This is the factory default state. When the system is set to redundant mode, the system settings and crosspoint configurations will be written to the internal flash memory and the micro SD card simultaneously (if present). If an SD card is not present, the internal serial flash is used to store the settings. This function is ideal for installations where redundancy is a requirement but also may be useful where multiple units are installed that require identical settings. Simply install the SD card in each system to overwrite the internal flash memory with the new settings.
- **SD Card Only Mode:** When the system is set to SD only mode, the system settings and crosspoint configurations will be written to the SD card only. The internal flash memory will not be used to retain any information. This is ideal for installations where customers require the utmost security without any mission specific data being stored in the system. Simply remove the SD card and all of your custom settings are removed with it.



10.1. microSD Card Decision Trees

The following diagrams are intended to assist the system operator with the internal workings of the SD card functions and identify how the system will behave in various scenarios.

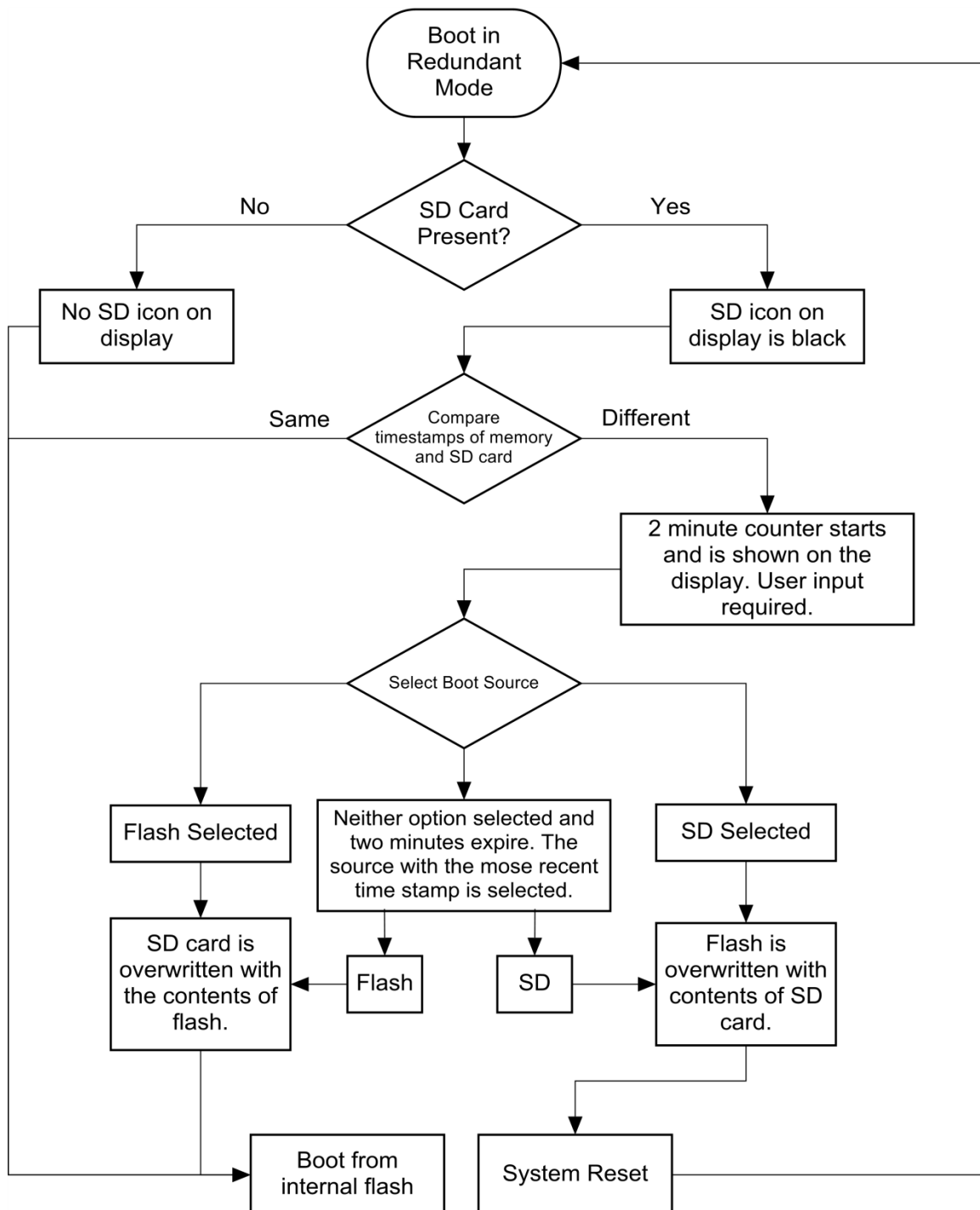

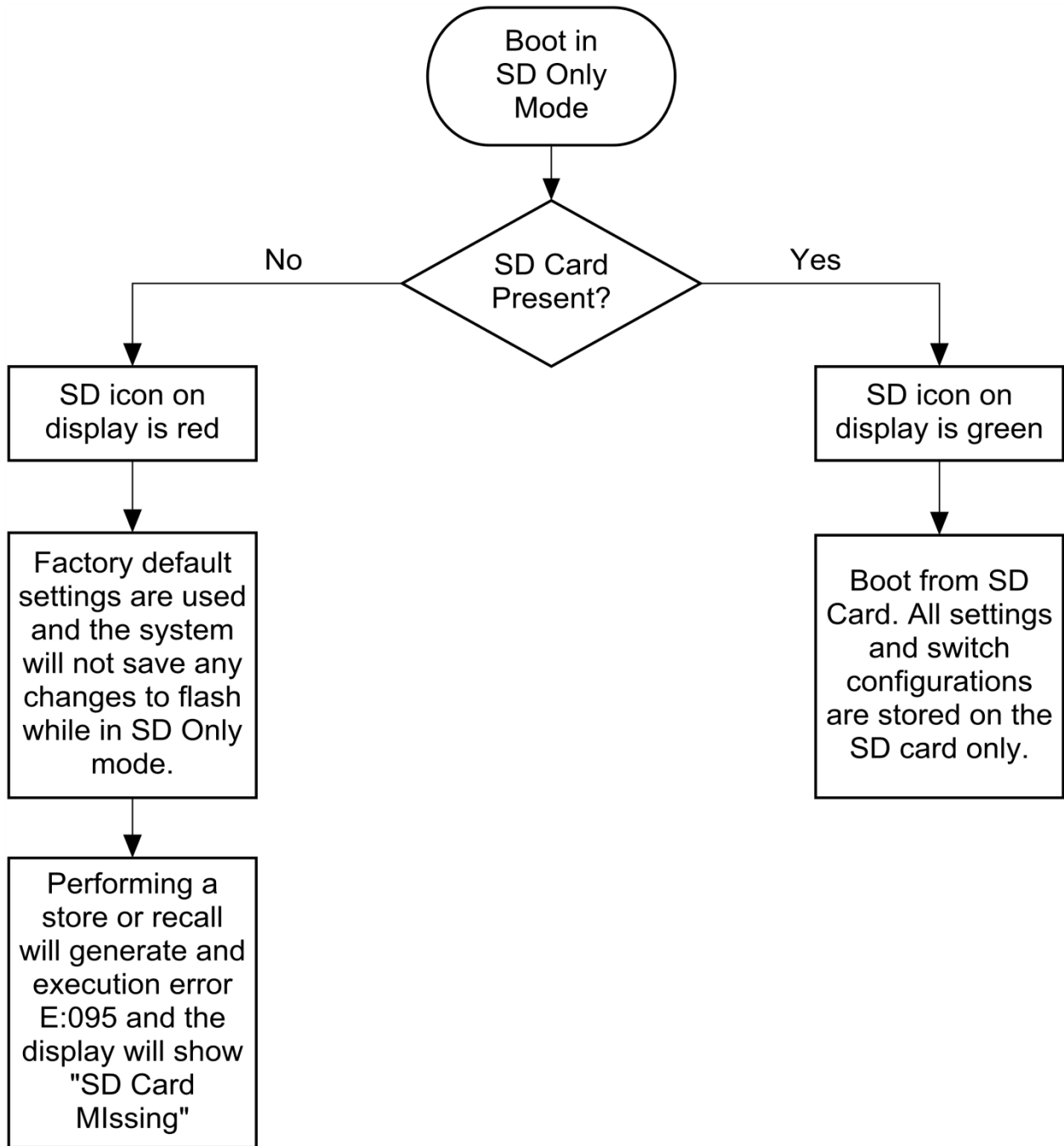

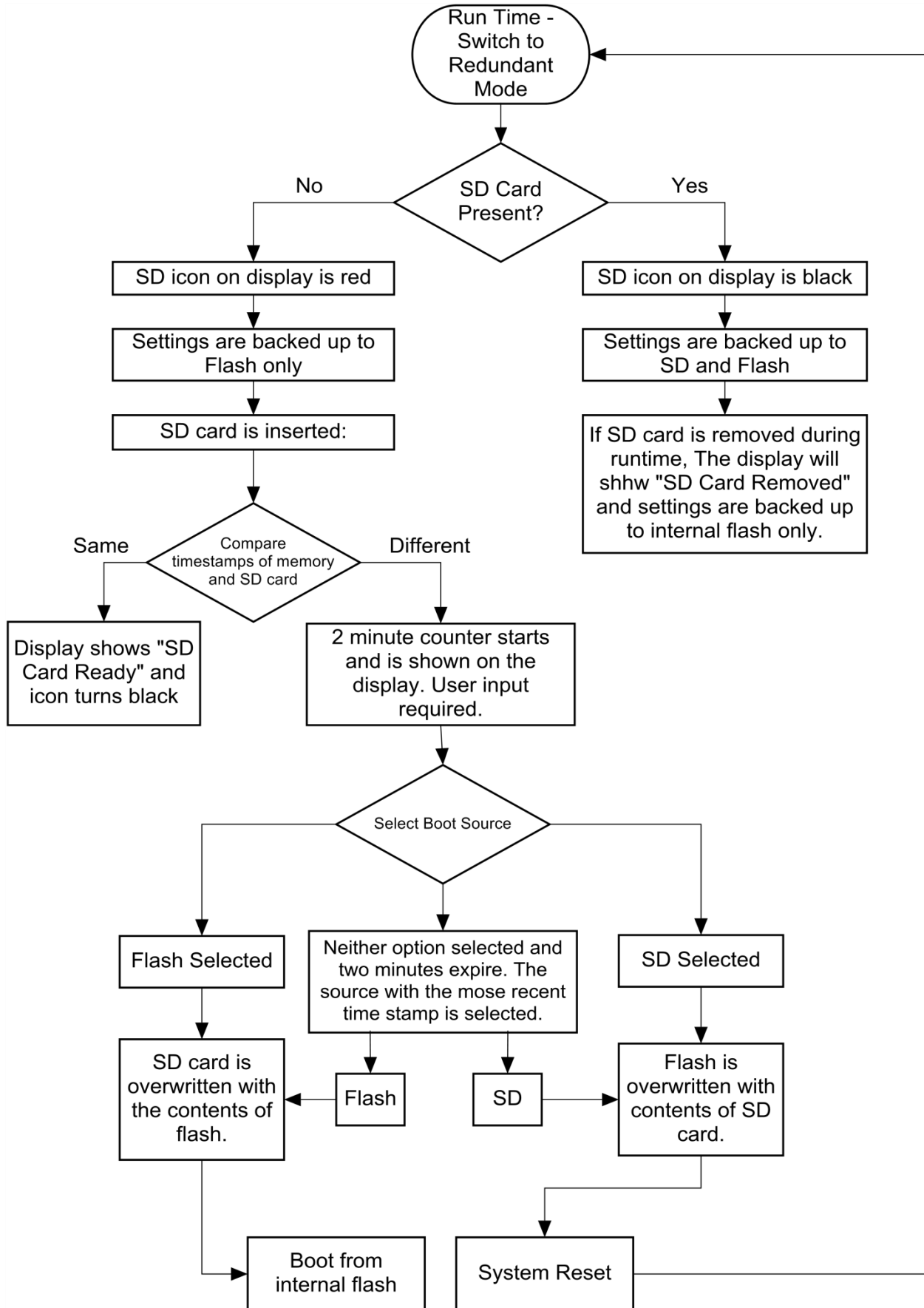

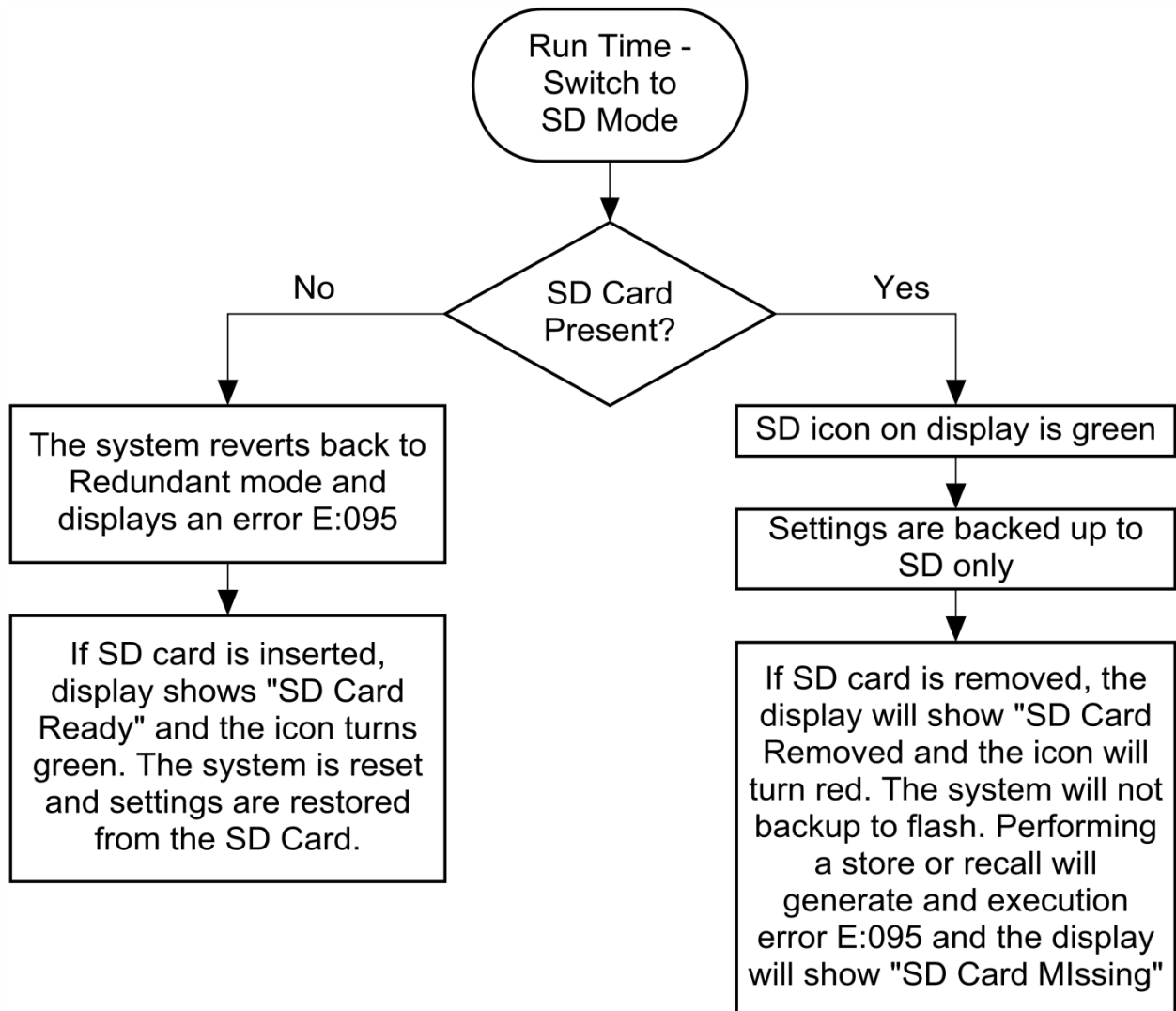

**THIS PAGE WAS
INTENTIONALLY LEFT
BLANK**

11. Troubleshooting

The series G2T system is robust in design and construction, and extremely reliable in operation. Each system is thoroughly tested and “burned in” at the factory prior to delivery. Usually, problems that occur are minor in nature and may be corrected in the field.

This section provides a diagnostic guide for troubleshooting in the field. For problems unable to be diagnosed and repaired in the field, the system or module should be returned to the factory.

Most problems may be classified into the following categories:

- Power
- Communications
- Mechanical Connections
- Operation and Performance



NOTE: Additional information is available at the Universal Switching Corporation website: www.uswi.com.

11.1. Power

If the system fails to power ON, ensure that there is power at the facility AC outlet source. Verify that the system AC cord is fully engaged in the duplex outlet and the system AC line input receptacle.

11.1.1. Circuit Breakers and Fuses

Verify that the system circuit breakers, located next to the AC power input, have not tripped. Circuit breakers may fail when they become old. If a circuit breaker has tripped, further diagnosis is required before powering ON the system. Contact Technical Support. If circuit breakers are not present on the rear of the system, refer to your systems Operations Manual for the location of the fuses on the power supply backplane.

11.1.2. Power Supply

Four (4) bi-color LED indicators are located on each plug-in power supply assembly. The indicators are driven by the built-in power supply monitoring CPU. If the power supply configuration is redundant, the supply voltage LED's will come on RED without the power supply's power switch being "ON". The power supply monitoring CPU receives power from the other power supply.



WARNING: High voltage is present at the power supplies. Never open a power supply while the system is powered ON. Failure to observe this WARNING could result in severe injury or death.

The power supply AC power switch is LED illuminated.

Most power supply units have three (3) DC sections, while others have only two (2) sections. If the power supply does not include a third DC section (V3), the LED will be off.

Below is the definition of the indicator colors.

Designation	Status Function	GREEN	RED
V1	VCC Power Section	Pass	Failure
V2	VDD Power Section	Pass	Failure
V3	VEE Power Section	Pass	Failure
Temp	High temp indication	Temp okay	Temp High

If there is out-of-range DC output on the V1, V2 or V3 power supply, the LED combination of RED (failure) and GREEN (pass) for the power supply LED displays ORANGE.



CAUTION: The system is configured with particular power supplies that are not interchangeable with other models. Always replace power supplies with the same model number. Failure to observe this CAUTION could result in damage to equipment.

11.1.3. Power Flowchart

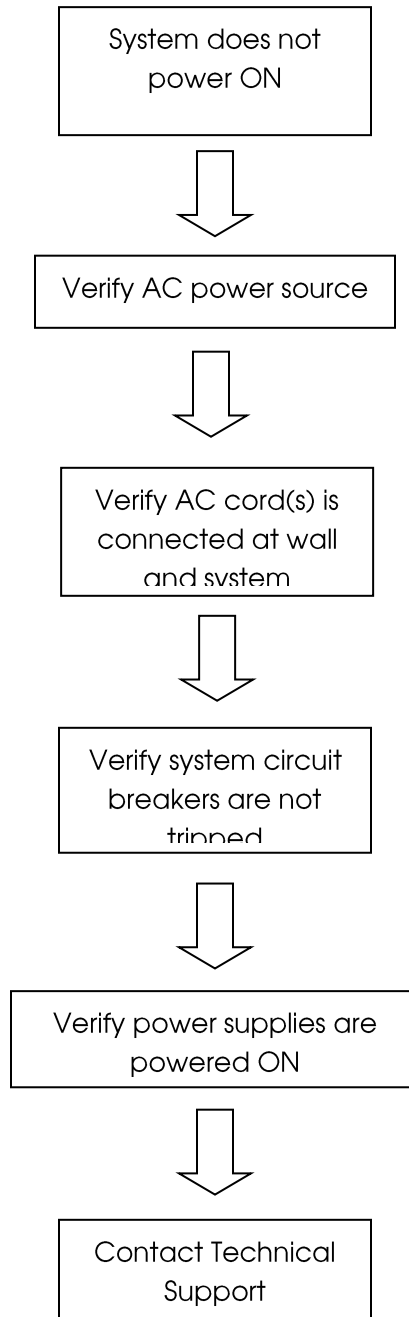

11.2. Communications

Communication problems are usually the result of improper system or host settings, or system configuration compatibility.

The IP and port address for the system are different when communicating with Ethernet and serial communications. Verify that the correct IP and port address are entered. Verify that the communications cable is connected to the proper port.

By default the system is shipped with DHCP mode enable. To enter a static IP address, you must first disable DHCP then enter your static IP information.

System configuration compatibility issues arise when attempting to communicate with a system using the wrong operating mode. The switching system can be enabled in AUTO-ROUTE mode or GANGED mode. Verify that the operating mode is set correctly.

The AUTO-ROUTE mode automatically routes the command entry to the system without the need to address a specific module number. Tri-Stage™ or Output End-to-End systems are configured in AUTO-ROUTE mode.

The GANGED mode does not require a specific module number to route correctly the command entry. Parallel systems may be configured in GANGED mode.

11.2.1. Ethernet Communications Flowchart

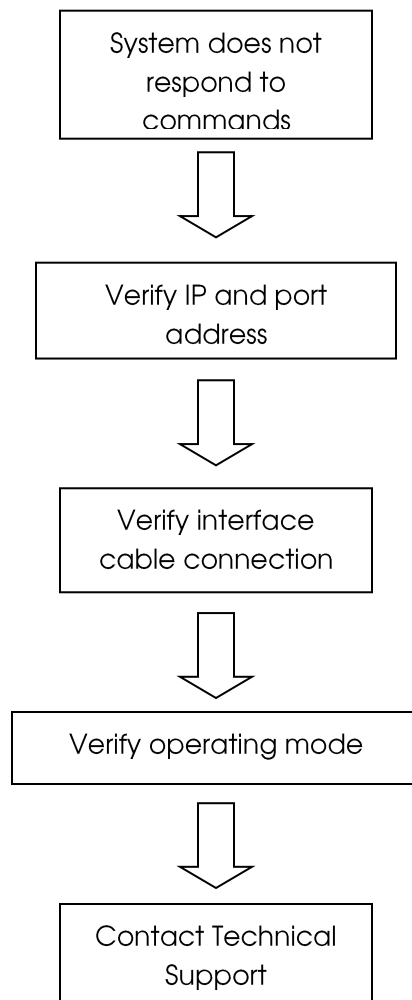

11.2.2. Serial Communications (RS-232, RS-422, RS-485) Flowchart

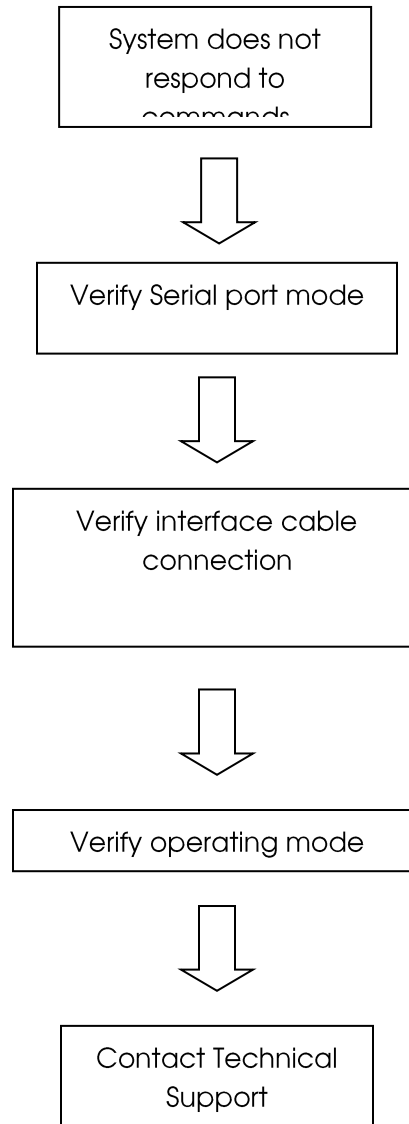

11.2.3. Mechanical Connections

Damage to power and control pins may occur when modules have been forced into place. Remove the module and, with a strong light, examine all power and control connector pins within the mainframe to ensure that they are not damaged.

Install the module and verify that the power and control connectors mate properly. Ensure that the module captive fasteners are tight.

Damage to signal cables may occur if signal cables have been pulled or subjected to continuous movement. Examine the signal cables for bent or improper routing. Excessive bends or recurring movement may weaken and fatigue signal cables.

Damage to relay connector jacks may occur when signal cable connectors have been over tightened. Examine relay connector jacks at the signal connector panel. Ensure that the signal cable connectors are tight.



NOTE: Be careful when tightening SMA connectors. The maximum torque rating that can be applied is 8 inch-pounds. Over tightening can damage the SMA connectors.

Damage to power and control pins may occur when the CPU has been improperly installed or forced into place. Remove the CPU and, with a strong light, examine all power and control connector pins within the mainframe to ensure that they are not damaged.

Verify that the CPU is fully seated and secured with attaching hardware.

Damage to power and control pins may occur when power supplies have been forced into place. Remove the power supply and with a strong light, examine all power and control connector pins within the mainframe to ensure that they are not damaged.

Verify that the power supplies are fully seated and secured with captive fasteners.

11.2.4. Mechanical Connections Flowchart

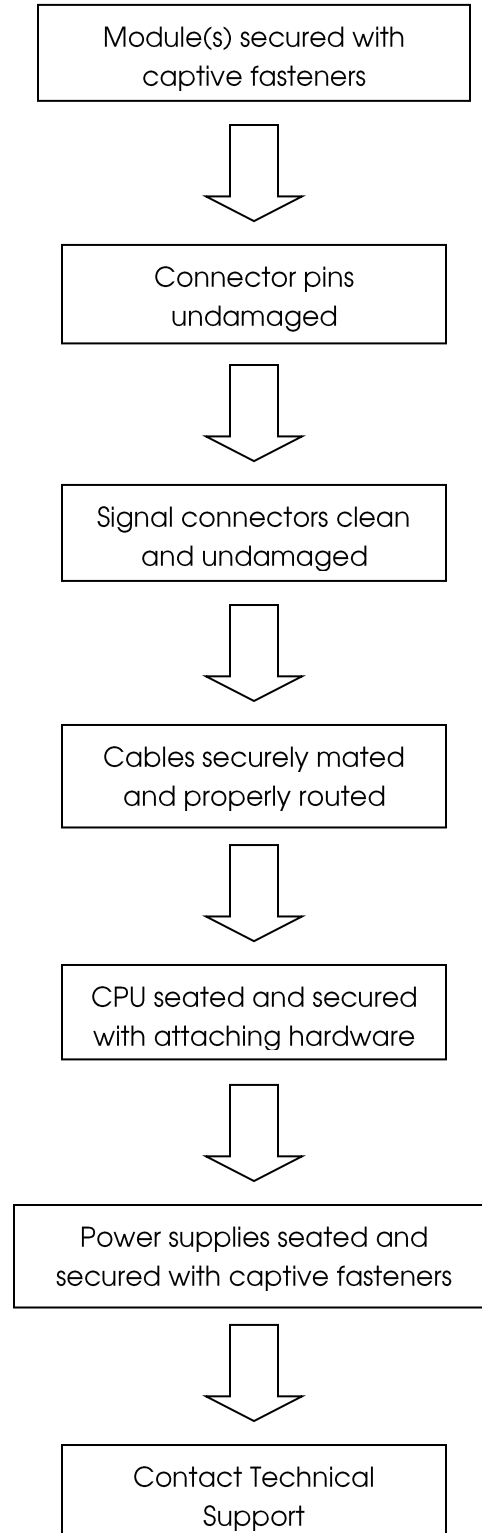

11.3. Performance

Degraded performance may result from a signal impedance mismatch. Ensure that the correct impedance is achieved by using cables and connectors for the required impedance.

11.3.1. Compatibility Issues

Incorrect system firmware causes compatibility errors. Perform a “*idn?” command from the host PC, and note the firmware that is displayed. Contact Technical Support if you suspect that there is a firmware issue. A firmware upgrade may be available.

11.3.2. Operation and Performance Flow Chart

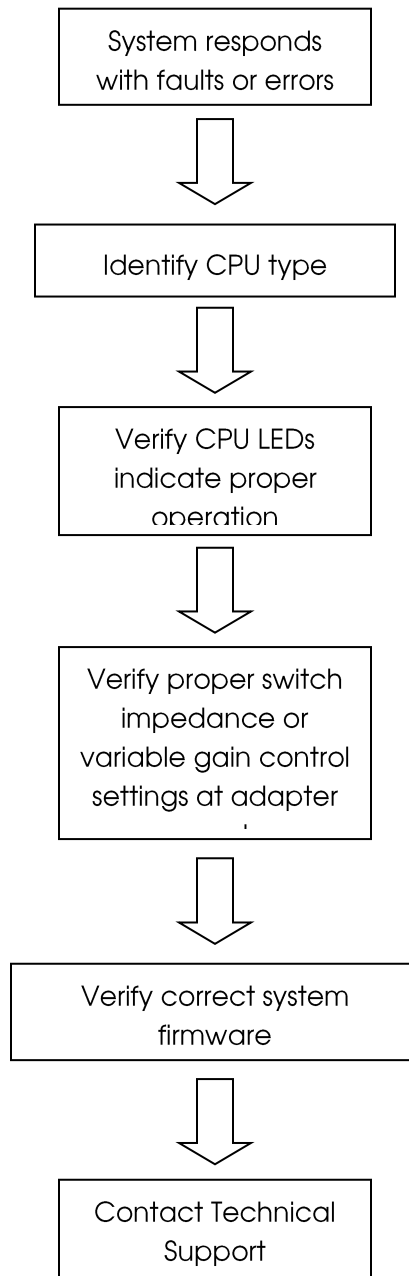

11.4. Technical Support

If you have any questions, contact Technical Support for assistance. A dedicated technician is available for immediate consultation. Every effort shall be made to provide customer support.

If any portion of the unit is required to be shipped back to the factory for service, contact the factory for an RMA number.

NOTE: Most problems may be solved in the field. Contact Technical Support. A technician is available for immediate consultation. If return of a module or system is required, an RMA number shall be assigned.

Attach a tag to the system identifying the current owner (including address and phone number) model and serial number of the equipment, as well as a brief description of the required service or suspected problem. Print the RMA number on the exterior of the packaging.

Use the original custom commercial packaging for shipping and mark the packaging **FRAGILE** to help insure safe handling by the carrier. In correspondence, refer to the return item by the model number and serial number.

When returning a module or system, use the following address:

Universal Switching Corporation
7671 North San Fernando Road
Burbank, CA 91505-1073 USA

Technical Support +1 818 381-5111
support@uswi.com

NOTE: Additional information is available at www.uswi.com

**THIS PAGE WAS
INTENTIONALLY LEFT
BLANK**

12. Control Software

12.1. RouteWarePRO

Our software product called [RouteWarePRO](#) is a self-contained graphical interface software package designed specifically to control and monitor Universal Switching Corporation's products. Designed for ease of use, most users are up and running in minutes. The user can control one "switch box" or many by simply selecting the "box" to be controlled from a menu. GUI colors, channel labeling and configuration uploads are all user definable.

RouteWarePRO Key Features:

- Real-time visual crosspoint connectivity window
- Sophisticated "auto-discovery" of available network attached USC hardware devices simplifies initial application setup
- Sort input and outputs by I/O number or by user channel/port names
- Fully scalable user windows for easy viewing of larger configurations
- "On the fly" input and output naming (channel or part names) within RWP
- Integrated screen color picker to customize "panels" for desired effects
- Multiple user OS support for different users on the same work station can either share settings and I/O names, or have custom program settings for their login
- Improved status with more indicators, plain English responses and handy tool hints
- Multiple instance support to operate multiple devices or device "panels" from a single computer
- Interlock control to prevent accidental user disconnects
- System diagnostic report generation for streamlining support of connected USC devices
- Software or Hardware Licensing options (via USB Key).

Please visit our website uswi.com for more information on RouteWarePRO.

12.2. National Instruments LabVIEW

Universal Switching Corporation has developed a VISA library that contains all the drivers necessary to control and monitor our products using National Instruments LabVIEW software.

You may download the VISA library by clicking on the link below or visiting our download website:

Download Package:

<http://www.uswi.com/downloads/LabVIEW/Uswi%20VISA.zip>

Website:

<http://www.uswi.com/Support/downloads.htm>

13. Index

1

10.1" Front Panel	47
About Unit	60
Auto Interlock	66
Auto-Route	66
Backlight Brightness	67
Classing	55
Clear Connections	63
Diagnostics	61
Event Log	62
Event Scheduler	69
Exclusion Table	65
Factory Reset	63
Ganged Mode	66
Input Signal Detection	52, 53
Intra-Matrix	66
Local Lock	49
Lock Code	50
Menu Tree	48
Real-Time Clock	67
Remote Control Settings	68
Settings	63
System Information	59
Unlock Code	49
Voltage Monitor	60
X-Point Control	50

4

4.3" Front Panel	11
About Unit	26
Application Title	15
Auto Interlock	38
Auto-Route	39
Background Color	32
Backlight Brightness	32
Backwards Compatibility	38
Classing	41
Clear Connections	29
Configure Unit	
Network	35
Serial	36
Connect	16
Diagnostic	25
Disconnect	16
Display Firmware	33
Display Preferences	32
Event Log	24
Event Scheduler	32
Exclusion Table	31
Factory Reset	29
Force Close	38
Ganged Mode	39
Home Screen	14

Intra-Matrix	40
Keypad	14
Labels	18, 19
Last Action	14, 35
Lock Screen	30
Menu	23
Menu Tree	13
Power On AutoRestore	31
Real-Time Clock	30
Recall	18
Relay Log	28
Remote Control Settings	34
Self Test	25
System Functions	28
System ID	44
System Information	23
Unlock Code	30
Verify	16
View Connections	19
Voltage Monitor	27

A

About Unit	26
Administrator	163
Auto Interlock	105
Auto-Route Mode	122

B

Backwards Compatibility	75, 105
Baud	36
Beeper On Error	31, 33, 64, 67

C

C3-001	129, 130, 131, 132, 134, 135, 138, 145
Circuit Breakers	172
Classing	41, 55, 100, 145
Command Error	115
Communications	172, 175, 176, 177
Control Protocols	
MSC	75
US2	75
US3	75
US4	75

D

Default Gateway	35
DHCP	35, 44, 107, 108, 130, 147
Diagnostic	25, 145, 158

E

End to End.....122
 Error Code.....125
 Ethernet 34, 44, 72, 129, 130, 131, 132, 134, 145, 162, 175, 176
 Ethernet - Rear 2RU37
 Event Log97, 145, 155
 Event Scheduler145, 159
 Event Status Enabled Register113
 Event Status Register 90, 91, 112, 113, 114, 120
 Exclamation Point44
 Execution Error 83, 84, 86, 115, 116, 117, 134

F

Factory Defaults.....133
 Fault Queue 112, 114, 117, 118, 119, 120
 Firmware..... 26, 60, 126, 129, 132, 145, 162
 Flash.....129
 Forclose.....105
 Fuses.....172

G

Ganged Mode123
 Ganging107, 126
 Parallel.....67
 Series.....66
 Gateway.....106, 107
 GPIB37, 73, 91, 107, 113, 114, 115, 119, 120, 132
 GUI26, 60, 72, 73, 130, 137, 145, 146, 184

I

IEEE 488.2 72, 77, 119, 120
 Input Signal Detection52, 53, 78
 Intra-Matrix107, 150
 IP Address..... 35, 106, 130

L

Labels..... 69, 93, 95, 145, 154
 LabVIEW.....185
 LAN Configuration.....145, 147
 LAN Status Indicator44
 LEDs134
 LXI37

M

MAC Address26, 60
 Maintenance.....156, 162
 Manufacturer.....164
 Master / Remote.....45, 71
 Mechanical Connections.....172, 178, 179
 microSD..... 31, 64, 127, 134, 166, 167
 Module ID19
 Module Information145

N

Network ID35, 107, 108, 131

P

Parallel..... 107, 122, 175
 Pin Assignment.....132
 Poles..... 107, 124
 Ports34, 73, 89, 92, 130
 Power105, 107, 112, 115, 126, 172, 173, 174
 Power On AutoRestore64
 Power Supply.....27, 60, 105, 107, 112, 173

Q

Query Error..... 105, 116

R

Real Time Clock 30, 97, 99
 Recovering Errors117
 Relay Log145, 157
 Remote Control
 *CLS 90, 120
 *ESE 91, 119
 *ESE?..... 91, 119
 *ESR? 91, 119
 *IDN?89
 *OPC 92, 121
 *OPC? 92, 121
 *PSC 91, 120
 *PSC? 92, 120
 *RCL88
 *RST 90, 120
 *SAV.....88
 *SRE 91, 119
 *SRE? 91, 119
 *STB? 90, 119
 *TST?.....90
 *WAI 92, 121
 BRE?.....84
 CIA.....101
 CID102
 CLI?104
 CLL.....103
 CLL?.....103
 CLO?.....104
 COA101
 COD102
 CON.....83
 CVE?.....81
 DAT98
 DAT?.....98
 DIS.....83
 ETH?.....87
 EXC77
 EXclude.....77
 EXL?.....77
 FOR89
 GET?..... 86, 105, 120

INC.....	77
INClude.....	77
ISP?.....	78
LIN.....	93
LIN?.....	94
LOC.....	87
LOG?.....	97
LOU?.....	94
LOUT.....	93
MAK?.....	83
OSP?.....	80
POA.....	92
POD.....	93
POL?.....	92
QUE?.....	85
QUEry.....	76
RES.....	89
SCA?.....	80
SET.....	86, 105
STL.....	95
STL?.....	96
TIM.....	97, 99
TIM?.....	97, 99
UNL.....	87
XCL.....	77
RouteWarePRO.....	45, 71, 184
RS-232C.....	107, 129, 131, 134

S

Screen Saver.....	32, 67
Serial.....	34, 107, 129, 131, 132, 134, 177
Baud Rate.....	36
Data Bits.....	36
Flowcontrol.....	36
Mode.....	36
Parity.....	36
Stop Bit.....	36

Serial Control.....	72
Serial Flash.....	15, 31, 71, 166
Service Request Enable Register.....	91, 112, 113
SNMP.....	72, 129, 135, 137, 139, 148
Browser.....	135
connectionTable.....	143
swCMD.....	142
swConfig.MIB.....	141
sysSettings.MIB.....	139
sysTRAP.MIB.....	139
Status Byte Register.....	90, 91, 111, 112, 113, 120
Subnet Mask.....	35, 106
Support.....	132, 164, 172, 180, 182, 185
Switch State.....	145, 150
Syntax Conventions.....	76
System Information.....	145, 146
System Settings.....	145, 149

T

TCP/IP.....	72, 89, 92, 93, 105, 114, 130
touchscreen.....	11
Troubleshooting.....	172

U

USB.....	72, 129, 131, 132
User Description.....	26, 60

V

Virtual Modules.....	124
VISA.....	72, 185

W

Web Interface.....	145
--------------------	-----

**THIS PAGE WAS
INTENTIONALLY LEFT
BLANK**

14. Record of Changes

This section only applies to revised documents. The table below indicates the revision level entered and a brief description of the change(s).

Revision	Description of Change	Date
Initial Release		20151216
A	<ul style="list-style-type: none"> • Added details on Classing: <ul style="list-style-type: none"> • Added Section 5.3.38 • Added Execution Error 24 (Section 7) • Added Section 9.12 	20160222
B	<ul style="list-style-type: none"> • Added 10.1" Touchscreen details – Section 3 • Updated Classing functionality via front panel in section 2.15 	20160602
C	<ul style="list-style-type: none"> • Added S2561F(X) / S2560F(X) functionality: <ul style="list-style-type: none"> • EXC? Query: Section 5.3.1.2. • ISP? Query: Section 5.3.1.5. • OSP? Query: Section 5.3.1.6. • SCA? Query: Section 5.3.1.7. • Updated index and table of contents 	20160929
D	<ul style="list-style-type: none"> • Added input signal detection mechanics on 10" front panel. • Added introductory video for the 10" screen on "VID" version of the document. 	20161024
E	<ul style="list-style-type: none"> • Added Sections: 2.7 / 2.12.3 / 0 / 2.18 / 3.3.3.1. / 3.6.1.5. / 5.3.1.8. • Updated Section 3.3.4 to discuss exclusions, • Updated Menu Trees in Sections 2.2 and 3.1 • Updated Section 7, added fault codes 97, 98, and 99 	20170905

F	<ul style="list-style-type: none">• Added GET?/SET value 92 and updated Error code 74 for Peer to Peer functionality.• Updated Section 8.5 to include SNMP v3• Added Section 5.3.40 for the TOP? Query• Added Section 5.3.41 for the UDES and UDES? Command and query• Updated Section 9.2 to allow user to disable HTTP port 80• Added Section 9.3 for the SNMP settings page	20190328
---	---	----------